



# Industrial Sectional Doors

With the innovative wicket door with trip-free threshold









4	Hörmann Brand Quality
6	Sustainable Production
8	Good Reasons to Try Hörmann
14	Door Fixtures and Fittings
16	Application Areas
18	SPU F42, SPU 67 Thermo
24	APU F42, APU F42 Thermo, APU 67 Thermo
28	ALR F42, ALR F42 Thermo, ALR 67 Thermo
32	ALR F42 Glazing, ALR 67 Thermo Glazing
36	ALR F42 Vitraplan
40	ALR F42 for On-Site Facade Design
	SPU F42 Parcel / SPU F42 Parcel Walk
44	APU F42 Parcel / APU F42 Parcel Walk
48	Wicket Doors
52	Side Doors
54	Colours
	DURATEC Glazing
56	with Maximum Scratch Resistance
58	Glazing Types
62	Track Versions
64	Advanced Technology in Every Detail
65	Safety Features
66	Manually Operated Doors
67	Handles
68	Break-in-Resistant Anti-Lift Kit
70	Leading Photocells
72	Light Grilles
74	Operators, Controls
82	Operator Accessories
89	Special Control Construction
90	Performance Characteristics
92	Construction and Quality Features
94	Hörmann Product Range

Copyright: No part or excerpt may be reproduced without our prior permission. Subject to changes. The doors shown are example applications – no guarantee.

Image on left: Strassenmeisterei (road maintenance authority) Sion, Switzerland



# Hörmann Brand Quality

Reliable and oriented towards the future



Mercedes Benz, Ostendorf



## In-house product development

At Hörmann, innovation is produced in-house – highly qualified employees of the development departments are in charge of product optimisation and new developments. This results in market-ready, high-quality products that are very popular around the globe.



## Modern manufacturing

All of the essential door and operator components, such as sections, frames, fittings, operators and controls are developed and manufactured by Hörmann. This guarantees a high degree of compatibility between the door, operator and controls. Our certified quality management system ensures the highest quality, from development through to production and delivery.

**This is Hörmann quality – Made in Germany.**





As Europe's leading manufacturer of doors, hinged doors, frames and operators, we are committed to high product and service quality. This is how we set standards on an international scale.

Highly-specialised factories develop and manufacture construction components that are marked by excellent quality, functional safety and a long service life.

Our presence in the global economy's key regions makes us a strong, future-oriented partner for industrial and public construction projects.



It goes without saying that spare parts for doors, operators and controls are original Hörmann parts that come with a guaranteed availability of 10 years.



### Competent advice

Experienced specialists within our customer-oriented sales organisation accompany you from the planning stage, through technical clarification up to the final building inspection. Complete working documentation, such as technical manuals, is not only available in printed form, but also always accessible and up-to-date at [www.hoermann.com](http://www.hoermann.com).



### Fast service

Our extensive service network means that we are always nearby and at your service around the clock. This is a great advantage for testing, maintenance and repairs.

# Sustainable Production

## For future-oriented construction

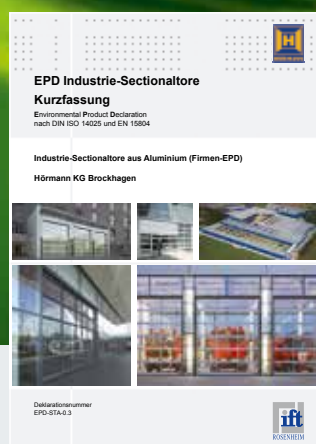
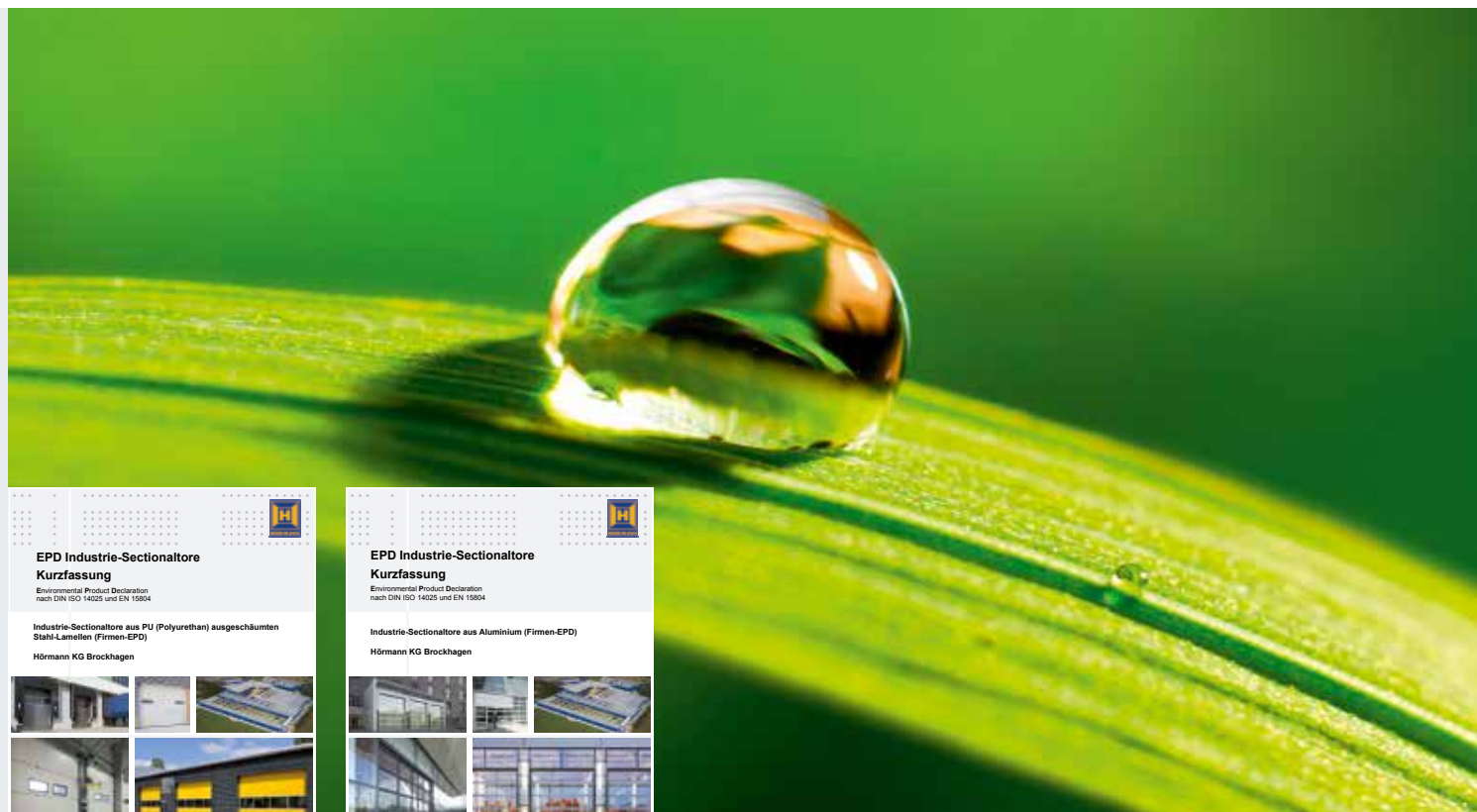

### Sustainability documented and approved by the ift in Rosenheim

Hörmann has already received confirmation of sustainability through an Environmental Product Declaration (EPD) in accordance with ISO 14025 from the Institut für Fenstertechnik (ift – Institute of window technology) in Rosenheim, Germany. This EPD was created based on EN ISO 14025:2011 and EN 15804:2012. In addition, the general guidelines for the preparation of type III Environmental Product Declaration apply. The declaration is based on the PCR document “Doors” PCR-TT-1.1:2011.

### Sustainably produced industrial sectional doors from Hörmann

- Ecological quality**  
Environmentally friendly production through a comprehensive energy management system
- Economical quality**  
A long service life and low maintenance costs thanks to the use of high-quality materials
- Process quality**  
Sustainable production processes through optimised material use

### Sustainable construction with Hörmann’s expertise

Hörmann has been able to gain great expertise in sustainable construction through various projects. We also apply this know-how to support your projects.



# Simple and Sustainable Planning

With the Hörmann Architects' Program and energy savings compass



## The Architects' Program

More than 9000 drawings for over 850 products

Planning with Hörmann products is now even easier thanks to a modern, user-friendly interface. Clearly structured navigation via drop-down menus and symbols, as well as a search function, provide faster access to texts for invitation of tenders and drawings (in DWG and PDF format) of over 850 Hörmann products. **In addition, BIM data can be provided for many products for the Building Information Modelling process, enabling efficient planning, drafting, construction and management of buildings.** Photos and photo-realistic presentations provide additional information on many products.



The Architects' Program is available to you as a web version at <https://www.hormann.co.uk/architects/architecture-consultation/architects-programme/> or can be downloaded free-of-charge from the Hörmann Architects' Forum.

## The energy savings compass for sustainable planning

Hörmann's energy saving compass shows how industrial door systems and loading technology are planned with energy-efficiency and sustainability in mind. An integrated calculation module estimates the amortisation period for door and loading technology systems.

The energy saving compass is available as a web-based interface for PC / MAC and mobile end devices.



Plan with the energy savings compass at:  
[https://www.hormann.co.uk/fileadmin/\\_country/UK/Energiesparkompass/Energy\\_savings\\_compass/ml\\_eskSCALEframe.html](https://www.hormann.co.uk/fileadmin/_country/UK/Energiesparkompass/Energy_savings_compass/ml_eskSCALEframe.html)



We are a member of the professional association for digital building products in the Federal Association of Building Systems e.V.

# Good Reasons to Try Hörmann

The market leader has all the innovations

Only from Hörmann



# 1

## A permanently clear view

Industrial doors with large glazing offer maximum transparency and plenty of natural illumination within the building. **The scratch-resistant DURATEC synthetic glazing provides a permanently clear view.** A special surface coating, similar to that used on car headlights, protects the pane from scratches and damage caused by cleaning over the long-term. This preserves the attractive appearance despite wear in rough industrial settings. **The DURATEC glazing is available as standard and at no extra charge for all sectional doors with clear synthetic glazing – only from Hörmann.**

For further information, see pages 56 – 59.



See the short film at:  
[www.hormann.co.uk/videos](http://www.hormann.co.uk/videos)

Only from Hörmann

ThermoFrame frame connection

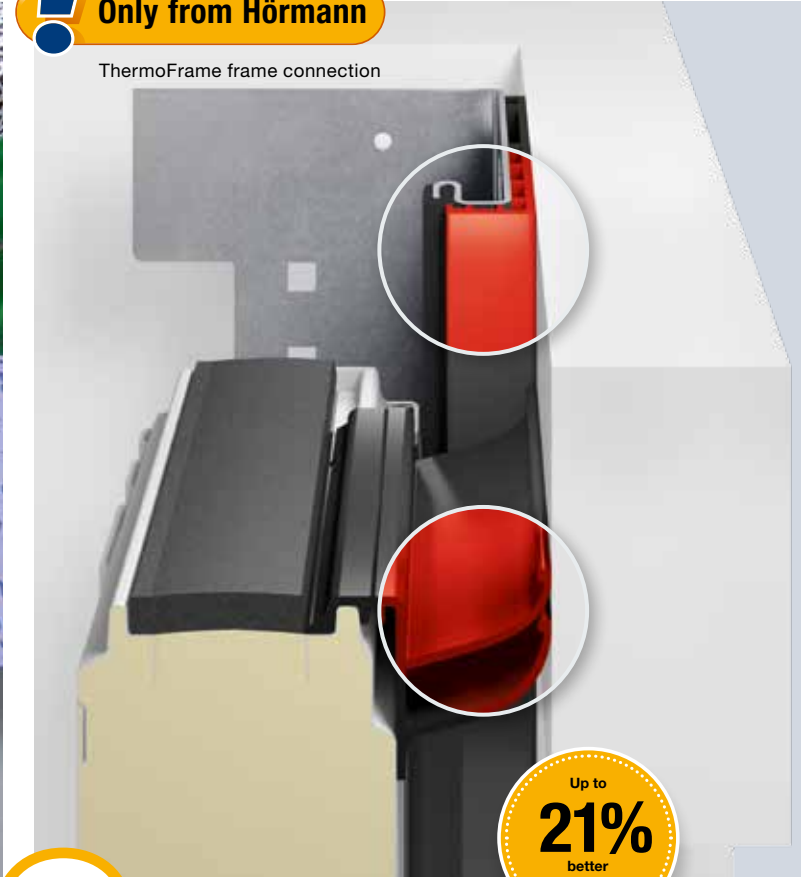

# 2

## Efficient Thermal Insulation

Well-insulated industrial sectional doors are essential in heated buildings to keep energy losses at a minimum. **Hörmann industrial sectional doors with 67 mm sections with thermal break offer very effective insulation and thus save energy costs.** Triple or quadruple panes with thermal break additionally limit the risk of condensation water accumulation. **You can additionally obtain up to 21 % better thermal insulation with the optional ThermoFrame frame connection,** which thermally separates the frame and the brickwork while also sealing the door better with double seals.

For further information, see pages 60 – 61.



**Wicket door construction  
with thermal break, depth 67 mm**



**3**

**Long-lasting  
design**

In every detail Hörmann industrial sectional doors are designed for a long service life: from rollers with ball-bearing via rugged section connections up to the optimal spring shaft equipment. This allows more than 25000 actuations with special equipment up to 200000. **The heavy-duty design lowers the maintenance and service costs, making Hörmann industrial sectional doors overall economic and sustainable.**

**4**

**Suitable  
fitting solutions**

With more than 30 track applications, industrial sectional doors **can be optimally matched to the architecture and requirements of your building.** Detailed solutions such as low-mounted spring shafts or screw-fitted components additionally facilitate maintenance and make the doors especially service-friendly.

For further information, see pages 62 – 63.

# Good Reasons to Try Hörmann

The market leader has all the innovations



# 5

## Optimised logistics systems

Hörmann industrial sectional doors and operators are **optimally matched to the Hörmann loading technology**. You therefore receive a logistics solution that perfectly matches your requirements in terms of thermal efficiency and functions. The industrial doors Parcel and Parcel Walk were especially developed for parcel services. They allow vehicles with different heights (such as lorries and transporters) to be effectively loaded and unloaded at a loading bay.

For further information, see pages 44 – 47.



**Only from Hörmann**

European patent

# 6

## Safe and convenient working



Sometimes minor things have major effects. The stainless steel threshold rail of Hörmann wicket doors is particularly flat – which facilitates working and minimises risk of accident. **This reduces the risk of tripping and makes it considerably easier for slide carriages to pass through.** Under certain circumstances, Hörmann wicket doors with trip-free threshold can even be used as escape doors and for barrier-free passages.

For further information, see pages 48 – 51.



See the short film at:  
[www.hormann.co.uk/videos](http://www.hormann.co.uk/videos)





# 7

## Harmonious design

Hörmann industrial sectional doors, doors with wicket door, side doors and panels are designed in such a way that all elements present a harmonious overall view when they are fitted in a line of buildings. **The rails of the aluminium frames are aligned to match** – for both standard profiles and profiles with thermal break. This also applies to the combination of doors with different depths. This way, your company will present its best look in all cases.



# 8

## Individual design possibilities

**With Hörmann industrial sectional doors you can design your facades according to your wishes.** Individual possibilities emerge from the integration of the doors in the facade with a flush-fitting design made of wood, metal, ceramics, plastic and other materials. The Vitraplan glazing offers an engaging mix of reflection and transparency. The wide glazing sections of the Glazing doors offer a free view of your exhibition areas.

For further information, see pages 36 – 43.

# Good Reasons to Try Hörmann

The market leader has all the innovations



# 9

## Break-in resistant as standard

It is also important for industrial doors to be reliably break-in-resistant to protect your building. The **standard anti-lift kit** functions mechanically and thus effectively protects your goods and machines during power outages. Additional security is offered thanks to an optional rotary latch and shootbolt as well as floor locking. Wicket doors are also optimally protected thanks to the optional multiple-point locking. They are protected against break-ins across the entire door height. You can also optionally equip side doors with break-in-resistant RC 2 security equipment.

For further information, please see page 68.

# 10

## User-friendly equipment

We offer you a wide range of optional equipment. This **allows you to conveniently adjust any door to your requirements**. For manually operated doors, there are operation aids such as pull rods, cable or chain hand pulleys. Or you can equip your door with an exterior handle to securely close it and conveniently open it from the outside. For power-driven doors we offer the suitable operator solutions with matching safety equipment, operating aids and signal transmitters.





**!** Only from Hörmann

Leading photocell



# 11

## Convenient operator solutions

For frequent door cycles we recommend the use of a power-driven door. Depending on the requirements regarding performance, speed and convenience, we offer you **perfectly matched operator solutions**. From the installation-friendly shaft operator WA 300 to the powerful shaft operator WA 400 FU, a suitable operator solution optimally supports the work processes of your company, making it an investment that quickly pays off.

For further information, see pages 74 – 79.

# 12

## Safe operation

Efficient monitoring of the closing edge increases safety, optimises your work processes and lowers inspection and maintenance costs. In addition to the standard closing edge safety device for operators WA 400 and ITO 400, **opt for a leading photocell at no surcharge** – it reacts without contact to movements and obstacles, securely stopping the door if required and moving it up again. Optionally, you can equip your doors with the light grille HLG that offers you maximum safety and particularly convenient features.

For further information, see pages 70 – 73.

# Door Fixtures and Fittings

## Section thicknesses, surface finishes and profile types

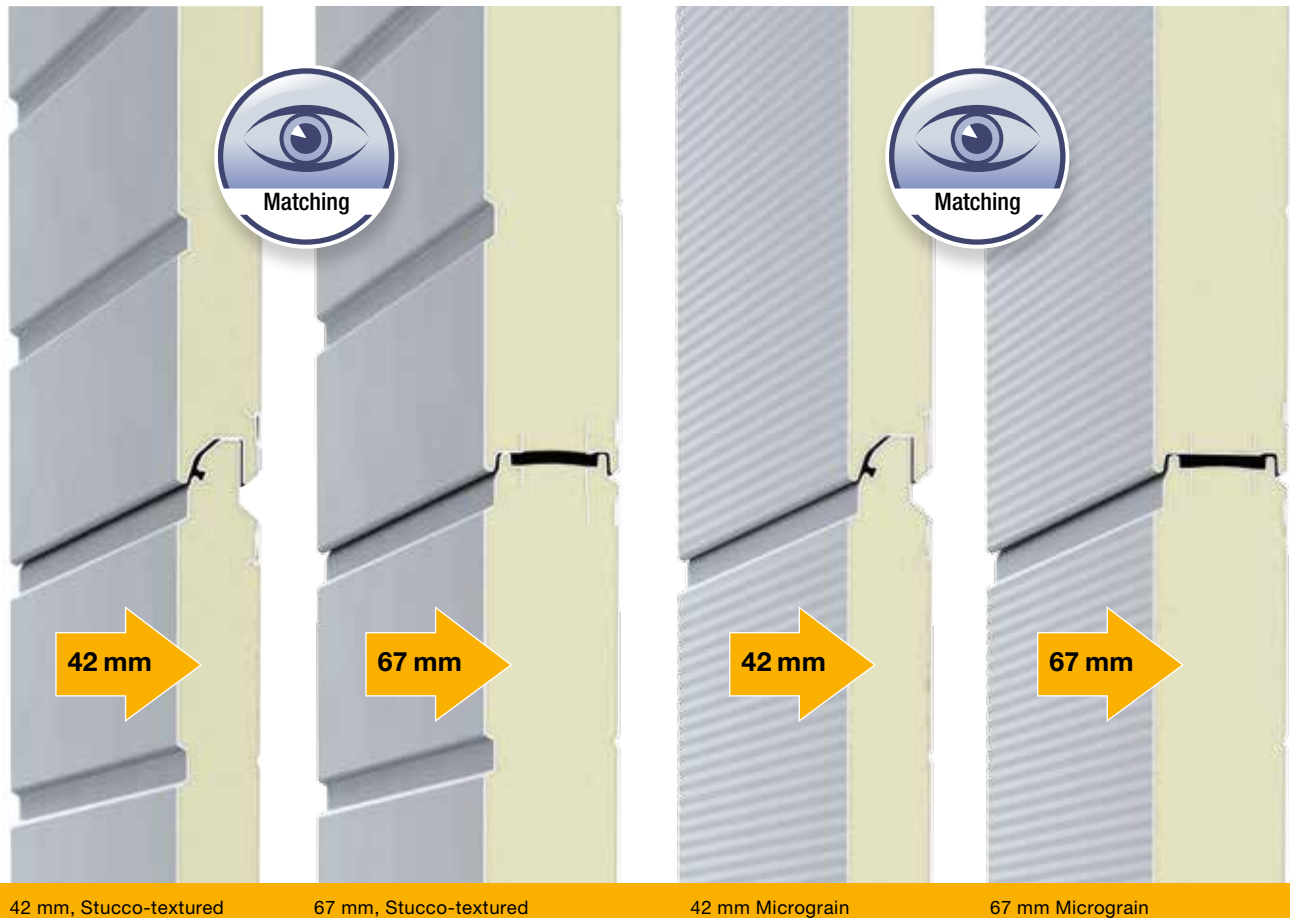

### PU-foamed sectional doors in 2 surfaces and 2 depths

PU-foamed sectional doors are available either with 42 mm depth or with sections with thermal break and 67 mm depth. For both versions, the door appearance is 100 % matching.

#### Depth 42 mm

Hörmann sectional doors with 42 mm thick PU-foamed sections are especially robust, offering good thermal insulation.

#### 67 mm depth with the best thermal insulation

With the SPU 67 Thermo's 67 mm sections with thermal break, you benefit from an excellent insulation value of up to  $0.51 \text{ W}/(\text{m}^2 \cdot \text{K})^*$ . The thermal break between the exterior and interior of the steel sections also reduces the formation of condensation water on the inside of the door.

The surface finish of the sections of steel doors or doors with bottom section is based on hot-galvanized sheet steel and a high-adhesion primer-coating (2-component PUR) that protect the door against adverse effects of the weather.

#### Resistant Stucco surface

Additionally, Stucco texturing gives the door surface a uniform structure on which light scratches or traces of dirt are more difficult to see.

#### The Micrograin surface finish results in an elegant look

Micrograin features a smooth surface and characteristic fine lines. This door surface finish harmonises especially well with modern facades that are characterised by their clear formal structure.

As standard, the inside of the door is Stucco-textured in Grey white, RAL 9002.

\* For a door size of 5000 x 5000 mm with optional ThermoFrame



**For ideal thermal insulation: 67 mm  
Thermo profiles with thermal break**



42 mm standard profile

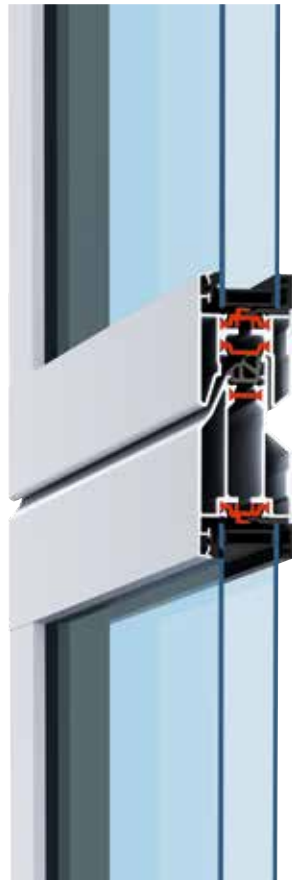

42 mm Thermo profile



67 mm Thermo profile

## **Glazed aluminium doors in 2 profile types and 2 depths**

### **Standard profile, depth 42 mm**

As standard, the glazing frames are produced using high-quality aluminium extrusion profiles that are designed for robust industrial and commercial day-to-day work. The standard profile without thermal break is ideal for buildings that are barely or not at all heated or cooled.

### **Thermo profile with thermal break, depths 42 mm and 67 mm**

Anywhere the thermal insulation of buildings is important, the Thermo profiles with thermal break on the interior and exterior are the first choice. The 67 mm Thermo profile with 3-chamber system is delivered with triple glazing as standard. The 42 mm Thermo profile is offered with double glazing as standard. Other glass variants, such as climatic glass or synthetic quadruple pane, can further increase energy efficiency.

# Application Areas

A matching door version for every purpose

## Saving Energy Thanks to Thermal Insulation

SPU F42  
SPU 67 Thermo  
Double-skinned steel  
sectional doors

Page 18



## More Light in the Building

APU F42  
APU F42 Thermo  
APU 67 Thermo  
Glazed aluminium doors  
with steel bottom section

Page 24



## Matching Modern Architecture

ALR F42  
ALR F42 Thermo  
ALR 67 Thermo  
Glazed aluminium doors

Page 28





## Maximum Transparency for Shop Windows

ALR F42 Glazing  
ALR 67 Thermo Glazing  
Aluminium doors with large glazing

Page 32



## Elegant Eye-Catcher

ALR F42 Vitraplan  
Exclusively glazed aluminium doors

Page 36



## Door and Facade Design

Aluminium door ALR F42  
for on-site cladding

Page 40



# SPU F42

## Double-skinned steel sectional doors



### Logistics buildings and warehouses

Easy and safe passage of pedestrians thanks to the wicket door with trip-free threshold

### Commercial buildings

Bring natural light into the building using optional glazing







**Everything from one source:  
Industrial doors, dock levellers, dock shelters**



**Agriculture**  
Robust thanks to PU-foamed panels



**Logistics**  
Operator WA 300 S4 (see page 74),  
the affordable solution for logistics doors



# SPU 67 Thermo

Double-skinned steel sectional doors with thermal break



## Logistics

Excellent thermal insulation with sections with thermal break, depth 67 mm

## Fresh logistics

The SPU 67 Thermo door minimises temperature losses at door openings, making it ideal for use in food and cold logistics.







**Excellent thermal insulation  
with a U-value of up to 0.51 W/(m<sup>2</sup>·K)**



**Commercial buildings**  
Easy and safe passage of pedestrians thanks to a wicket door with thermal break and trip-free threshold



**Commercial buildings and warehouses**  
Bring natural light into the building using optional glazing





# SPU F42 / SPU 67 Thermo

## Double-skinned steel sectional doors



### SPU F42

**1** The 42-mm-thick PU-foamed section with finger trap protection is especially robust and offers good thermal insulation. The door leaf is available in the Stucco-textured and Micrograin surface variants.

### SPU 67 Thermo

**2** Optimum thermal insulation is achieved with the SPU 67 Thermo, featuring 67 mm thick sections with thermal break without finger trap protection\*. Both surface variants for the door leaf match the SPU F42.



\* In the available size range, these doors comply with the requirements of EN 13241

Door type	SPU F42		SPU 67 Thermo	
	Without wicket door	With wicket door	Without wicket door	With wicket door
<b>Door size</b>				
Max. width (mm)	8000	7000	10000	7000
Max. height (mm)	7500	7500	7500	7500

#### Thermal insulation EN 13241, Appendix B EN 12428

U-value in W/(m<sup>2</sup>·K) for a door surface of 5000 × 5000 mm

Closed sectional door	1,0	1,2	0,62	0,82
With ThermoFrame	0,94	1,2	0,51	0,75
Section	0,50	0,50	0,33	0,33

## Optimum thermal insulation in 2 section surface finishes

The PU-foamed sections are particularly robust and offer good thermal insulation. Especially with the 67-mm-thick sections you benefit from very high thermal insulation, achieved thanks to the thermal break between the interior and exterior of the steel sections. This also minimises the formation of condensation water on the inside of the door. You can choose between Stucco-textured and Micrograin surface finish, both without a surcharge. The Stucco-textured surface features uniform ribbing every 125 mm in the section and in the section transition.



Sections with thermal break in SPU 67 Thermo



Stucco-textured

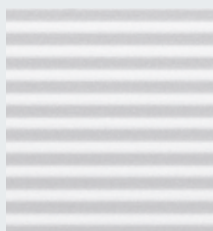

Micrograin

Colour options, page 54  
Glazings, page 56  
Safety features in acc. with EN 13241, page 65  
Technical data, page 90

## Example door versions

**Door width up to 4500 mm** (example 4500 × 4500 mm)

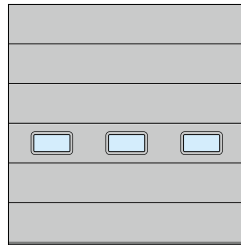

SPU F42  
Type E section windows  
Uniform field division

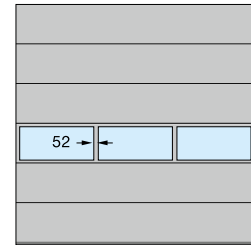

SPU F42, SPU 67 Thermo  
Aluminium glazing frames  
Uniform field division

**Door width up to 5500 mm** (example 5500 × 4500 mm)

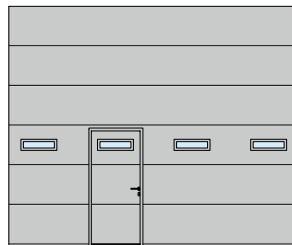

SPU F42, SPU 67 Thermo  
Type D section windows  
Wicket door arrangement to the left

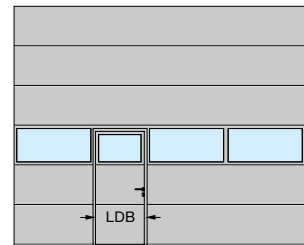

SPU F42, SPU 67 Thermo  
Aluminium glazing frames  
Wicket door arrangement to the left

**Door width over 5500 mm** (example 7000 × 4500 mm)

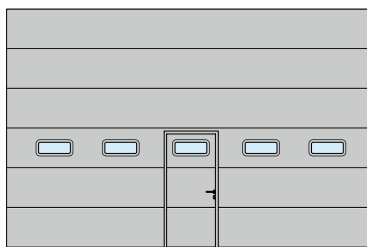

SPU F42, SPU 67 Thermo  
Type A section windows  
Wicket door arrangement in the centre

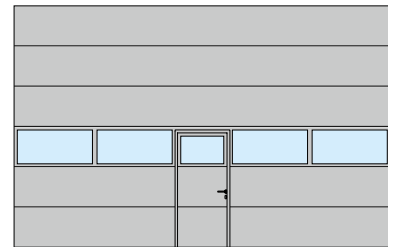

SPU F42, SPU 67 Thermo  
Aluminium glazing frames  
Wicket door arrangement in the centre

Clear passage width (LDB)  
SPU F42: 940 mm  
SPU 67 Thermo: 905 mm

On request, the SPU F42 Plus is available in the same door styles and surface finishes as Hörmann sectional garage doors.



For more detailed information, please see the Sectional Garage Door brochure.

# APU F42, APU F42 Thermo, APU 67 Thermo

Glazed aluminium doors with steel bottom section



## Workshops

Matching glazing division for doors with and without wicket doors



## Commercial buildings and warehouses

The PU-foamed bottom section can be replaced easily and inexpensively if damaged, for example, by a vehicle.

## Protection bollards protect from damage

When used outside, they avoid expensive collision damage on buildings. When used inside, they protect the door tracks from collision damage.



*Especially easy to service and repair  
thanks to robust bottom sections*



**Workshops**

Easy and safe passage of pedestrians thanks to the wicket door with trip-free threshold



**Workshops**

Large glazings for light in the workspace

# APU F42, APU F42 Thermo, APU 67 Thermo

Glazed aluminium doors with steel bottom section



## APU F42

**1** Thanks to the combination of robust steel bottom section and large glazings, the door is especially stable and lets a lot of light into the building.

## APU F42 Thermo

**2** The APU F42 Thermo with glazing beads with thermal break and steel bottom section is recommended for high thermal insulation requirements.

## APU 67 Thermo

**3** The APU 67 Thermo, depth 67 mm, offers excellent thermal insulation thanks to its glazing beads with thermal break and steel bottom section.



Door type	APU F42		APU F42 Thermo		APU 67 Thermo	
	Without wicket door	With wicket door	Without wicket door	With wicket door	Without wicket door	With wicket door
<b>Door size</b>						
Max. width (mm)	8000	7000	7000	7000	10000	7000
Max. height (mm)	7500	7500	7500	7500	7500	7500

### Thermal insulation EN 13241, Appendix B EN 12428

U-value in W/(m<sup>2</sup>·K) for a door surface of 5000 × 5000 mm

Standard double pane	3,4	3,6	2,9	3,1	-	-
With ThermoFrame	3,3	3,6	2,8	3,1	-	-
Standard triple pane	-	-	-	-	2,1	2,3
With ThermoFrame	-	-	-	-	2,0	2,2
Optional climatic double pane, single-pane safety glass	2,5	2,7	2,0	2,2	1,6	1,8
With ThermoFrame	2,4	2,6	1,9	2,1	1,5	1,7

# APU 67 Thermo: Excellent Thermal Insulation with a U-Value of up to 1.5 W/(m<sup>2</sup>·K) for a Door Size of 5 × 5 m

## Robust bottom section

The 750-mm-high bottom section is optionally available in Stucco or Micrograin surface finish without surcharge. The even PU-foaming of the steel section makes it particularly robust. In case of extensive damage, it can be exchanged easily and inexpensively.



Stucco-textured bottom section



Micrograin bottom section

## Example door versions

Door width up to 4500 mm (example 4500 × 4500 mm)

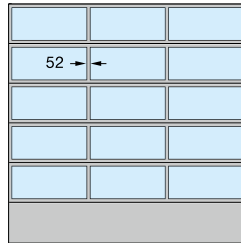

APU F42, APU F42 Thermo,  
APU 67 Thermo  
Uniform field division

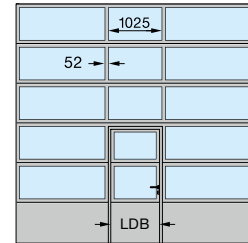

APU F42, APU F42 Thermo,  
APU 67 Thermo  
Wicket door arrangement in the centre

Door width up to 5500 mm (example 5500 × 4500 mm)

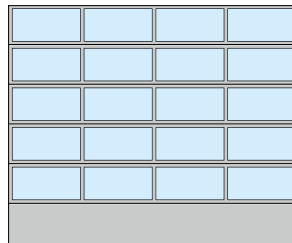

APU F42, APU F42 Thermo,  
APU 67 Thermo  
Uniform field division

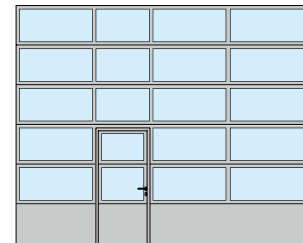

APU F42, APU F42 Thermo,  
APU 67 Thermo  
Wicket door arrangement to the left

Door width over 5500 mm (example 7000 × 4500 mm)

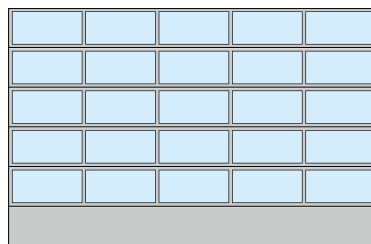

APU F42, APU F42 Thermo,  
APU 67 Thermo  
Uniform field division

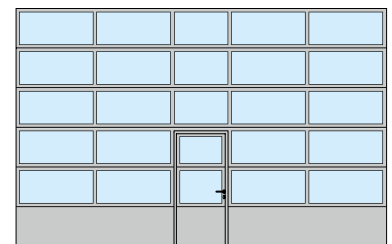

APU F42, APU F42 Thermo,  
APU 67 Thermo  
Wicket door arrangement in the centre

Clear passage width (LDB)  
APU F42, APU F42 Thermo: 940 mm  
APU 67 Thermo: 905 mm

On request, uniform field division is also possible with wicket door.

The field division of the wicket door arrangement is also available for sectional doors without wicket door.

For modernisation or when the matching appearance of the existing sectional doors must be ensured, the APU F42 / APU F42 Thermo is also available with 91-mm-wide rails.

Colour options, page 54  
Glazings, page 56  
Safety features in acc. with EN 13241, page 65  
Technical data, page 90



# ALR F42, ALR F42 Thermo, ALR 67 Thermo

Glazed aluminium doors



## Commercial buildings

Aluminium profiles with thermal break and optional climatic glazing ensure that insulation is improved by up to 55 %.

**Permanent clear view with DURATEC glazing  
for maximum scratch resistance**



**Workshops**

Permanent clear view thanks to standard DURATEC glazing



**Fire station buildings**

Large glazings offer more light in the building.



**Collective garages**

Variety of infill options, from expanded mesh to perforated sheet infill for door and wicket door (only ALR F42)

# ALR F42, ALR F42 Thermo, ALR 67 Thermo

## Glazed aluminium doors



### ALR F42

**1** This door features large glazings and a contemporary appearance with aluminium profiles. The DURATEC glazing provides a permanently clear view.

### ALR F42 Thermo

**2** Thanks to the glazing profiles with thermal break and DURATEC synthetic glazing, the door offers excellent transparency and good thermal insulation.

### ALR 67 Thermo

**3** The ALR 67 Thermo, depth 67 mm, with glazing beads with thermal break is recommended for the highest thermal insulation requirements.



Door type	ALR F42		ALR F42 Thermo		ALR 67 Thermo	
	Without wicket door	With wicket door	Without wicket door	With wicket door	Without wicket door	With wicket door
<b>Door size</b>						
Max. width (mm)	8000	7000	7000	7000	10000	7000
Max. height (mm)	7500	7500	7500	7500	7500	7500

#### Thermal insulation EN 13241, Appendix B EN 12428

U-value in W/(m<sup>2</sup>·K) for a door surface of 5000 × 5000 mm

Standard double pane	3,6	3,8	3,0	3,2	-	-
With ThermoFrame	3,6	3,8	3,0	3,2	-	-
Standard triple pane	-	-	-	-	2,2	2,4
With ThermoFrame	-	-	-	-	2,1	2,3
Optional climatic double pane, single-pane safety glass	2,7	2,9	2,1	2,3	1,7	1,9
With ThermoFrame	2,6	2,8	2,0	2,2	1,6	1,8



# Up to 55 % improved thermal insulation: ALR 67 Thermo with climatic glazing and ThermoFrame

## The best thermal insulation

For ALR F42 Thermo and ALR 67 Thermo, the aluminium profiles have a thermal break and offer optimum thermal insulation while letting in maximum levels of natural light. The ALR 67 Thermo with optional climatic glazing and ThermoFrame decreases the thermal insulation value by approx. 55 % to up to 1.6 W/(m<sup>2</sup>·K), in comparison to an ALR F42.

## Optional infills

We deliver the bottom door section as standard with PU infill and aluminium sheet cover, both sides Stucco-textured. Optionally, the door is available fully glazed without surcharge. Further information about the infill variations is available on page 58.



Bottom door section with PU infill (left) or optionally with glazing (right)

Colour options, page 54  
Glazings, page 56  
Safety features in acc. with EN 13241, page 65  
Technical data, page 90

## Example door versions

Door width up to 4500 mm (example 4500 × 4500 mm)

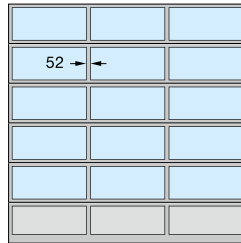

ALR F42, ALR F42 Thermo,  
ALR 67 Thermo  
Uniform field division

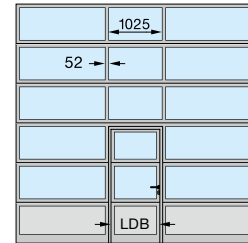

ALR F42, ALR F42 Thermo,  
ALR 67 Thermo  
Wicket door arrangement in the centre

Door width up to 5500 mm (example 5500 × 4500 mm)

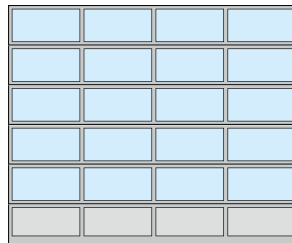

ALR F42, ALR F42 Thermo,  
ALR 67 Thermo  
Uniform field division

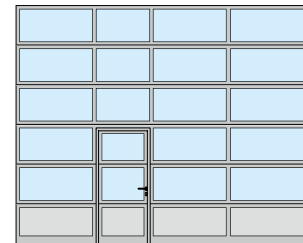

ALR F42, ALR F42 Thermo,  
ALR 67 Thermo  
Wicket door arrangement to the left

Door width over 5500 mm (example 7000 × 4500 mm)

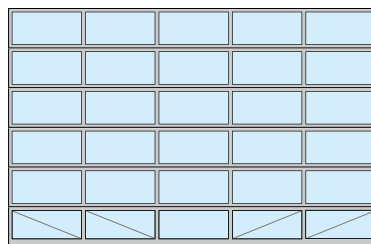

ALR F42, ALR F42 Thermo,  
ALR 67 Thermo  
Uniform field division  
Fully glazed

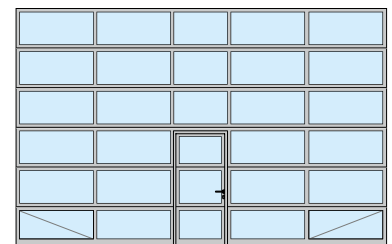

ALR F42, ALR F42 Thermo,  
ALR 67 Thermo  
Wicket door arrangement in the centre  
Fully glazed

Clear passage width (LDB)  
ALR F42, ALR F42 Thermo: 940 mm  
ALR 67 Thermo: 905 mm

On request, uniform field division is also possible with wicket door.

The field division of the wicket door arrangement is also available in doors without wicket door.

For modernisation or when the matching appearance of the existing sectional doors must be ensured, the ALR F42 / ALR F42 Thermo is also available with 91-mm-wide rails.

Of course, individual arrangements of the glass and panel infills or full glazing are possible.

For better stability, the lower window sections are equipped on the inside with diagonal static cross struts for the following door versions:

- Fully glazed doors from a door width of 5510 mm
- Doors with real glass and wicket door from a door width of 4510 mm

# ALR F42 Glazing, ALR 67 Thermo Glazing

Aluminium doors with large glazing



## Sales areas

Thanks to large glazings made of real glass, the door becomes a display window, attracting potential customers.





**Car showrooms**

Bright, well-lit showrooms convey a sense of space and professionalism.



**Warehouses**

Large glazing provides workplaces with daylight.



# ALR F42 Glazing, ALR 67 Thermo Glazing

## Aluminium doors with large glazing

REAL GLASS

### ALR F42 Glazing

**1** The ideal display window door: continuous window sections with real glass offer an unimpeded view into showrooms. The window sections, all the exact same height, are produced without vertical rails for door widths of up to 3330 mm.

### ALR 67 Thermo Glazing

**2** For higher thermal insulation requirements, the ALR 67 Thermo Glazing is available with thermal break profiles, depth 67 mm.



Door type	ALR F42 Glazing	ALR 67 Thermo Glazing
<b>Door size</b>		
Max. width (mm)	5500	5500
Max. height (mm)	4000	4000

#### Thermal insulation EN 13241, Appendix B EN 12428

U-value in W/(m<sup>2</sup>·K) for a door surface of 5000 × 5000 mm

Standard single pane, laminated safety glass	6,1	–
Standard double pane, single-pane safety glass	–	3,0
With ThermoFrame	–	2,9
Optional climatic double pane, single-pane safety glass	2,7	1,8
With ThermoFrame	2,6	1,7

## ALR F67 Thermo Glazing

The ALR 67 Thermo Glazing is especially suited for heated sales areas. The aluminium profiles have a thermal break and offer the best thermal insulation with maximum transparency.

The ALR 67 Thermo Glazing with optional climatic glazing and ThermoFrame decreases the heat transfer coefficient to a maximum of  $1.7 \text{ W}/(\text{m}^2\cdot\text{K})$ . This helps you save valuable energy.



ALR 67 Thermo Glazing with aluminium profiles with thermal break

## Example door versions

**Door width up to 3330 mm**  
(Example  $3300 \times 3500 \text{ mm}$ )

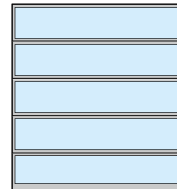

ALR F42 Glazing, ALR 67 Thermo Glazing

**Door width over 3330 mm**  
(Example  $4500 \times 3500 \text{ mm}$ )

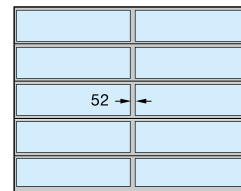

ALR F42 Glazing, ALR 67 Thermo Glazing with vertical rail

Colour options, page 54  
Glazings, page 56  
Safety features in acc. with EN 13241, page 65  
Technical data, page 90

For modernisation or when the matching appearance of the existing sectional doors must be ensured, the ALR F42 glazing is also available with 91-mm-wide rails.

# ALR F42 Vitraplan

Exclusively glazed aluminium doors



## Exclusive door appearance

A clear overall appearance thanks to the offset glazing with a fascinating mix of reflection and transparency



**ALR F42 Vitraplan**  
**An eye-catcher for prestigious buildings**  
**and modern architecture**



**Matching side doors**

The combination of the sectional door and matching side door with offset glazing creates a harmonious overall appearance.



**Designed facades**

Permanent surface protection thanks to standard DURATEC glazing

# ALR F42 Vitraplan

## Exclusively glazed aluminium doors



### ALR F42 Vitraplan

**1 2** The surface-mounted, flush-fitting glazing fascinates with a mix of reflection and transparency. The colours of the frame profiles are matched to the glazing colours in grey or brown.

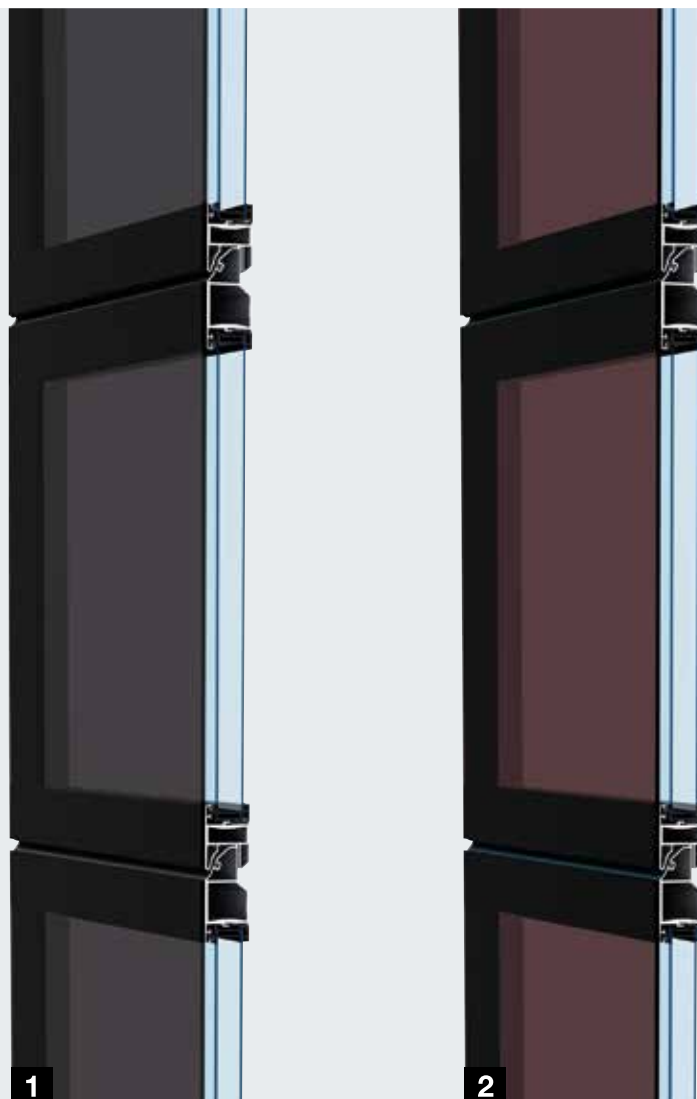

<b>Door type</b>	<b>ALR F42 Vitraplan</b>
<b>Door size</b>	
Max. width (mm)	6000
Max. height (mm)	7500
<b>Thermal insulation EN 13241, Appendix B EN 12428</b>	
U-value in W/(m <sup>2</sup> ·K) for a door surface of 5000 × 5000 mm	
Standard double pane	3,2
With ThermoFrame	3,2
Optional triple pane	3,1
With ThermoFrame	3,1

## ALR F42 Vitraplan For sophisticated architecture

The ALR F42 Vitraplan is especially elegant thanks to offset, flush-fitting glazing. The frame profile is concealed, so nothing detracts from the clear overall appearance.

Continuous glazing adds an eye-catching element to modern industrial structures and prestigious private buildings.

The door can be harmoniously integrated into the facade with glazings in brown and grey, as well as a dark frame profile colour that harmonises with the glass.



1  
Synthetic pane, grey



2  
Synthetic pane, brown

Glazings, page 56  
Safety features in acc. with EN 13241, page 65  
Technical data, page 90

## Example door versions

**Door width up to 4500 mm**  
(Example 4500 × 4500 mm)

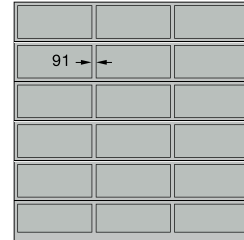

ALR F42 Vitraplan  
Uniform field division

**Door width up to 5500 mm**  
(Example 5500 × 4500 mm)

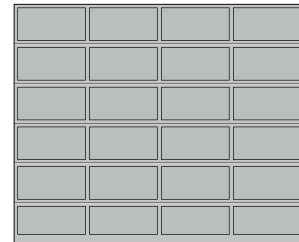

ALR F42 Vitraplan  
Uniform field division



# ALR F42

Aluminium doors for on-site cladding



On-site cladding with aluminium compound board



On-site cladding with timber panels

*For flush-fitting cladding made of timber,  
metal and many other materials*



**On-site cladding with laminated material boards**

# ALR F42

## Aluminium doors for on-site cladding

### ALR F42

The facade cladding door base consists of frame profiles with PU sandwich infill. The horizontal profiles are cladded. Optionally, we provide vertical fitting profiles to which the facade material can be attached simply and unseen.

You can design the on-site, flush-fitting facade cladding according to your wishes with timber, metal, ceramic, plastic and many other materials. Please observe the maximum weight per unit area of the on-site cladding. For further information, see the planning aid at [www.hoermann.com](http://www.hoermann.com)



<b>Door type</b>	<b>ALR F42</b>
<b>Door size</b>	Depending on weight of on-site cladding
Max. width (mm)	7000
Max. height (mm)	4500
<b>Thermal insulation EN 13241, Appendix B EN 12428</b>	
U-value in W/(m <sup>2</sup> ·K) for a door surface of 5000 × 5000 mm	
PU sandwich infill	2,6



## Excerpt from the planning aid

Standard fitting in the opening

### Standard version

- 1 Horizontal view – door frame connection to the facade wall
- 2 Vertical view of the section transitions

### Version with fitting profiles (red)

- 3 Horizontal view – door frame connection to the facade wall
- 4 Vertical view of the section transitions

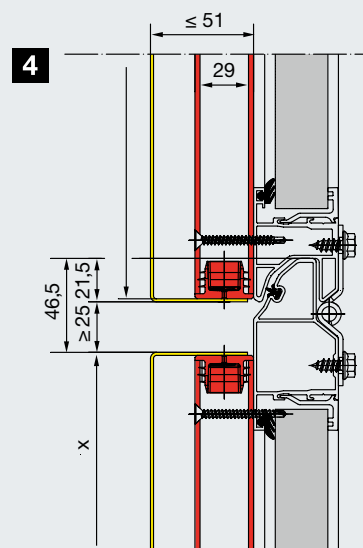
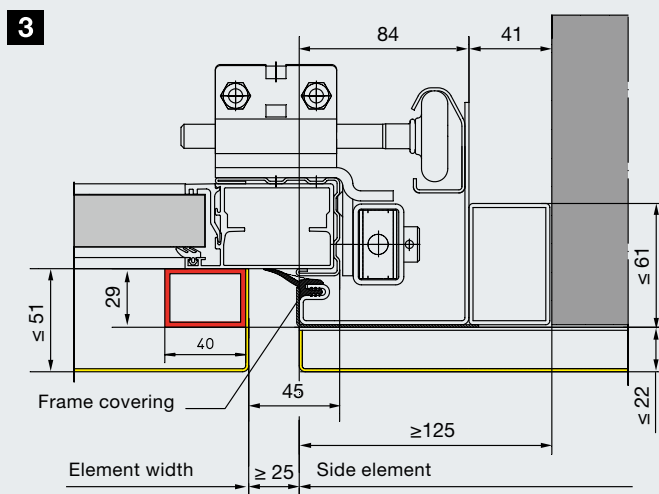
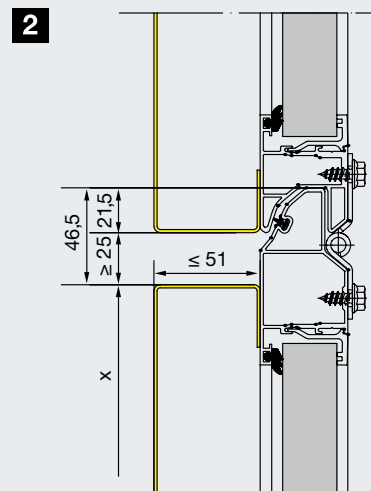
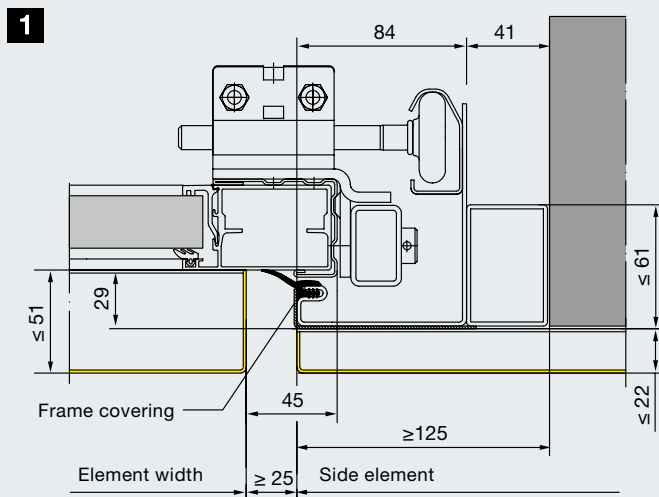

Colour options, page 54  
 Safety features in acc. with EN 13241, page 65  
 Technical data, page 90

For detailed planning documents, please visit:  
<http://www.hoermann.de/fileadmin/dokumentationen/anleitungen/garagen-sectionaltore/Fassadentor>

# Industrial Sectional Door Parcel / Parcel Walk

The divisible industrial door for joint use of the same loading bay by both lorries and vans







The catwalk enables easy access to the lorry's loading surface.



The divisible industrial door has been specially developed for logistics centres e.g. of parcel services.



# Industrial Sectional Door Parcel / Parcel Walk

Dual utility specifically for parcel services

In parcel service logistics centres or warehouses, different loading bays were previously required to load and unload lorries or swap trailers and transit vans. The loading floor heights for vans are, at 55 cm, much lower than those for lorries and swap trailers, which are approx. 1.35 m.

With the Parcel Walk industrial door, both types of vehicles can be loaded and unloaded at one loading bay. For loading lorries or swap trailers, the bottom section with the catwalk is disconnected from the door and only the top part of the door is opened. Using the catwalk, the lorry or swap trailer can be easily accessed for loading. When loading vans, the door is completely opened, including the bottom section, and the bottom section and catwalk remain in the top part of the door opening. The Parcel version is not equipped with a catwalk.

## Advantages through the dual use of the loading bay:

- Lower investment costs for e.g. conveyor belts, loading bays
- Lower manpower costs due to fewer loading bays
- More efficient loading bay utilisation through dual use



For loading lorries and swap trailers, the bottom section with the catwalk remains on the ground when the door is open.



Vans are loaded at floor level. For this purpose, the door is opened completely including the bottom section



### Easy decoupling

Releasing the espagnolette lock decouples the lower segment. This lowers the lock into a recess in the catwalk.



### Safe and convenient operation

The door is operated using a DTH-R push button (press-and-hold operation). Glazing in the door enables looking outside.



### Doubly secure door travel

Both door segments are counterbalanced by separate springs. The power limit of the WA 300 additionally protects against damage from possible obstructions.

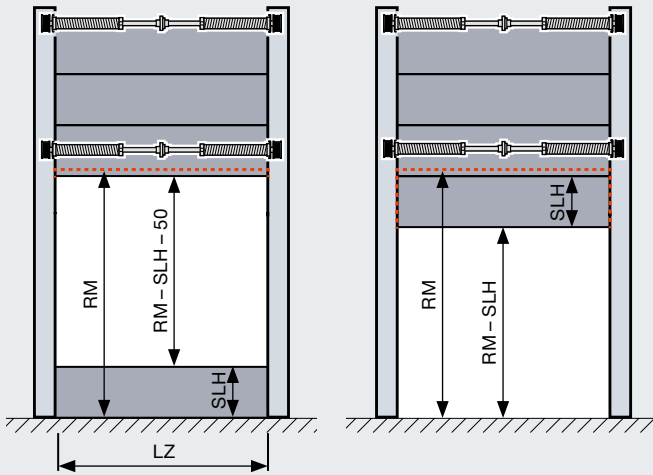

When the coupled door is opened (right figure), the bottom section with the catwalk remains in the top part of the door opening.

Door type	SPU F42 Parcel	SPU F42 Parcel Walk	APU F42 Parcel	APU F42 Parcel Walk
<b>Door size incl. bottom section</b>				
Max. width LZ (mm)	1500 – 3000		1500 – 3000	
Max. height RM (mm)	3125 – 4250		3125 – 4250	
Bottom section heights SLH (mm)	500 – 1450		500 – 1450	
Max. opening heights (RM – SLH – 50) (mm)	2575 – 3700		2575 – 3700	
<b>Catwalk</b>				
	Without	With	Without	With
Interior width (mm)	–	300 – 600	–	300 – 600
Exterior width (mm)	–	175 – 400	–	175 – 400
<b>Thermal insulation EN 13241, Appendix B EN 12428</b>				
U-value in W/(m <sup>2</sup> ·K) for a door surface of 5000 × 5000 mm				
Closed sectional door	1,0		–	
Standard double pane	–		3,4	
<b>Track application versions</b>	HP track application, VP track application			
<b>Door operation</b>	With operator WA 300 (press-and-hold control) and DTH-R push button			
<b>Options</b>	Shootbolt for use as night door rotary latch			



See the short film at:  
[www.hormann.co.uk/videos](http://www.hormann.co.uk/videos)

# Wicket Doors with Trip-Free Threshold

as a fully-fledged escape route



European patent





## Wicket door construction with thermal break, depth 67 mm



### Trip-free passage

Wicket doors with trip-free threshold pose less of a risk for persons stumbling and injuring themselves. Tool cars or trolleys can easily pass over the particularly flat stainless steel threshold with rounded edges.

The wicket door with trip-free threshold has many benefits:

- The door does not need to be opened for pedestrian traffic
- It reduces the risk of tripping and makes it easier to wheel things through
- Power-driven doors feature a leading photocell VL 2 with two sensors which causes the door to reverse on encountering an obstruction well before contact is made
- The wicket door contact ensures that the main door can only be opened when the wicket door is closed

### 905 / 940 mm clear passage width as standard

Under certain circumstances, the wicket door with trip-free threshold, with its clear passage width of 905 mm (depth 67 mm) or 940 mm (depth 42 mm), fulfils the requirements of an escape door and for barrier-free construction.

### As an escape door

Under certain circumstances, Hörmann sectional doors with a wicket door and trip-free threshold fulfil the requirements of an escape door (for doors up to 5500 mm width or for doors with real glass up to 4510 mm width).

### As a barrier-free entrance

Under certain conditions, Hörmann sectional doors with a wicket door and trip-free threshold fulfil the requirements for accessibility in accordance with DIN EN 18040-1 and are certified by the IFT Rosenheim.

### Freely selectable position

The wicket door can be positioned to the left, right or at the centre (except for the two outer fields). The window sections above the wicket door have a clear view of 1025 mm as standard. All other sections of the door have identical widths.



See the short film at:  
[www.hormann.co.uk/videos](http://www.hormann.co.uk/videos)

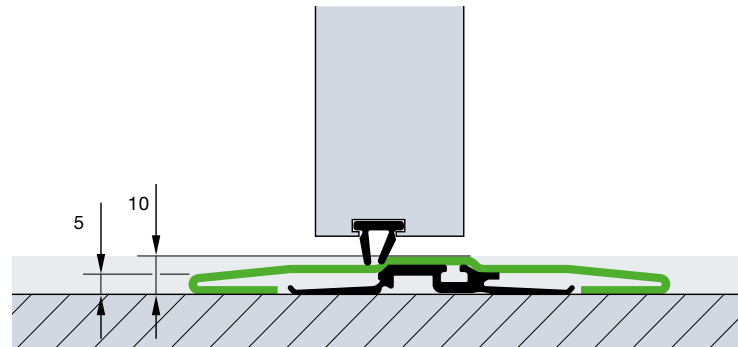

The stainless steel threshold is 10 mm high at the centre and 5 mm at the edges. We provide a reinforced threshold rail of approx. 13 mm for doors from 5510 mm width or for doors with real glass from 4510 mm width. **For doors with real glass in the wicket door area already starting at 4510 mm door width!**

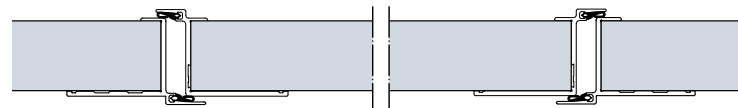

Wicket door construction for sectional doors with 42 mm depth

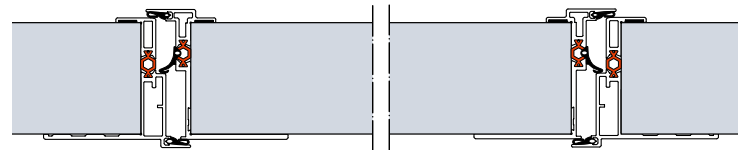

Wicket door construction with thermal break, for sectional doors with 67 mm depth

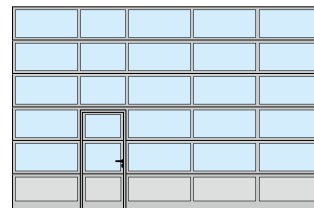

Wicket door arrangement to the left

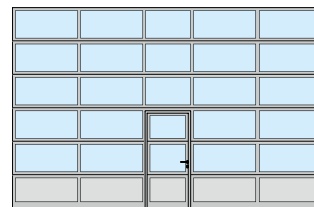

Wicket door in the centre



Wicket door to the right

On request, doors with wicket door are also available with uniform field division and the wicket doors can be supplied in individual sizes or matching existing doors, even with threshold rails. We recommend the wicket door with threshold rail for inclining surfaces in the opening area.

# Wicket Doors with Trip-Free Threshold

with high-quality equipment



## Standard with concealed hinges



### Overhead door closers

As standard, wicket doors are supplied with slide rail door closers incl. hold-open device (top figure). An integrated door closer, including hold-open device (bottom figure), is optionally available for doors with 42 mm depth for optimum protection and the best appearance.



### Optional multiple-point locking

The wicket door is locked over the entire door height with one bolt and hook bolt per door section. The advantage: better stability and improved break-in resistance.



### Robust door catch

This prevents door leaf dropping and buckling.



### Flat wicket door frame

The all-round frame consists of a flat aluminium profile. This way, the wicket door is harmoniously integrated into the door.



### Concealed hinges

For a uniform door appearance, the wicket doors are equipped with concealed hinges as standard.



### Finger trap protection

As standard on the interior and exterior of wicket door frames (except for wicket door with 67 mm depth)



### Optimally sealed

The adjustable threshold profile with flexible seal compensates for unevenness in the floor.

Adjustable double seals located in the transitions from the bottom edge of the door to the floor and from the door leaf to the threshold rail optimally seal the bottom edge of the door and the wicket door opening.

**Only Hörmann wicket doors with trip-free threshold can be used without restriction in automatic operation thanks to the leading photocell VL 2.**



# Side Doors

## Matching the door



### Side door NT 60

- 60 mm aluminium frame construction
- As standard with all-round seals made of long-lasting, weather-resistant EPDM
- Infill variations the same as for sectional doors with 42 mm depth
- Infill fixed by glazing beads

### Side door with thermal break NT 80 Thermo

- 80 mm aluminium frame construction with thermal break
- As standard with all-round seals made of long-lasting, weather-resistant EPDM
- Infill variations with thermal break the same as for sectional doors with 42 mm and 67 mm depth
- Infill fixed by glazing beads

### Fittings

- Mortice lock with profile cylinder
- Offset lever handle set with oval rose escutcheons, made of black plastic
- On request also available as lever / knob handle sets
- Optionally available in natural finish cast aluminium, polished stainless steel or brushed stainless steel

### Optional equipment

- Tested break-in-resistant RC 2 security equipment according to DIN EN 1627
- Stainless steel push bar 38-2, brushed, 1000 mm high, outside, additionally with stainless steel lever handle set, inside
- Overhead door closer with hold-open device
- Push bar for escape door, inside (panic lock required)
- Multiple-point locking also with anti-panic functions B, D, E



Side door NT 60 viewed from outside



Viewed from inside with synthetic glazing



Viewed from inside with sections



Lever handle set as standard



Side door NT 80 Thermo viewed from outside



Viewed from inside with triple synthetic glazing



Lever handle set as standard



Door leaf, frame and threshold with thermal break.



### Steel side doors with thermal break

#### MZ Thermo65 multi-purpose door

- 65-mm-thick door leaf with thermal break and PU rigid foam infill
- Aluminium block frame with thermal break and threshold with thermal break
- High thermal insulation with a U value = 0.82 W/(m<sup>2</sup>·K)
- Optionally available in an RC 2 version as KSI Thermo46 with 46-mm-thick door leaf



For further information, see the "Steel Doors" brochure

# Individual Colour Schemes

For greater design freedom





**No surcharge for preferred colours for double-skinned steel sections with 42 mm and 67 mm depth**

## High-grade colour coating

The primer-coating of all industrial sectional doors from Hörmann is available in 10 preferred colours, as well as RAL and NCS, in many metallic colours as well as acc. to British Standard.\*

The 2-component PUR coating on the exterior or on the exterior and interior and the coil coating procedure for double-skinned sections in preferred colours ensures high-quality, long-lasting colour. This maintains the attractive appearance of your door.

In addition you can receive the following with optional colour coating: wicket door frame profiles (external), leaf frame and frame of the side doors NT 60 and NT 80 Thermo, aluminium glazing frame, glazing beads, external frame of sandwich glazings type A (diecast frame) and type D (plastic frame).



Doors with double-skinned steel sections in any of the 10 preferred colours are supplied in Grey white, RAL 9002, on the inside (SPU F42 shown). The frames for sandwich glazing are black as standard on the interior of the door.



Door leaf reinforcements and the end caps of the door sections on the inside of coloured doors are supplied in Grey white, RAL 9002, as standard\*\*. For doors with wicket door, the frame of the wicket door on the inside consists of aluminium profiles in E6 / C0.

## 10 preferred colours

	Traffic white	RAL 9016
	Pure white	RAL 9010
	Grey aluminium	RAL 9007
	White aluminium	RAL 9006
	Grey white	RAL 9002
	Terra brown	RAL 8028
	Anthracite grey	RAL 7016
	Moss green	RAL 6005
	Gentian blue	RAL 5010
	Flame red	RAL 3000

Dark colours should not be used for double-skinned steel doors and for doors with thermal break that are exposed to the sun, as possible section deflection may restrict the door's function (bi-metal effect).

The colours shown are subject to the limitations of the printing process and cannot be regarded as binding. Contact your Hörmann specialist dealer for advice regarding coloured doors. All colours based on RAL.

\* With the exception of pearl-effect and fluorescent colours. Slight colour variations are permissible.

\*\* Except for ALR F42 Vitraplan

# Maximum Scratch Resistance and Good Thermal Insulation

As standard for Hörmann sectional door glazing



## A permanently clear view

The DURATEC glazing is available as standard and at no surcharge for all sectional doors with clear synthetic glazing.

With DURATEC synthetic glazing, Hörmann sectional doors retain their clear view permanently, even after multiple cleanings and heavy use.

## Better protection against scratches caused by cleaning

A special surface coating, similar to that used on car headlights, protects the pane from scratches and damage caused by cleaning over the long-term.



See the short film at:  
[www.hormann.co.uk/videos](http://www.hormann.co.uk/videos)

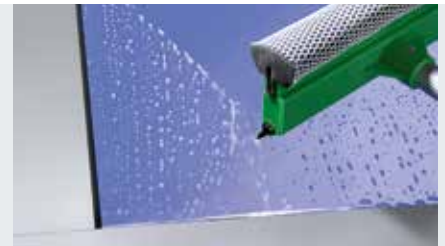

DURATEC synthetic glazing with maximum scratch resistance



Sensitive, common synthetic glazing

## Excellent thermal insulation as standard

Conventional double pane, 16 mm from other manufacturers

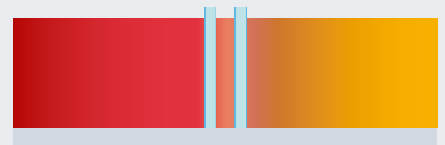

### DURATEC double pane, 26 mm

Compared with conventional 16 mm glazing, the standard 26 mm double pane improves thermal insulation by up to **20 %**.

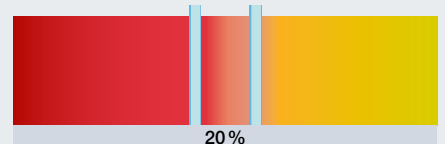

### DURATEC triple pane, 26 mm

The optional triple glazing increases the effective thermal insulation by up to **35 %** in comparison to conventional 16-mm-thick glazing.

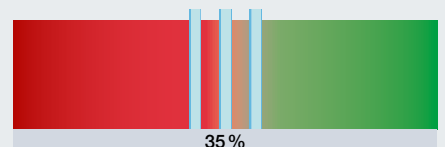

### DURATEC triple pane, 51 mm

Thermal insulation is improved by up to **40 %** thanks to the optional triple glazing with a pane thickness of 51 mm, compared to a 16-mm-thick glazing.

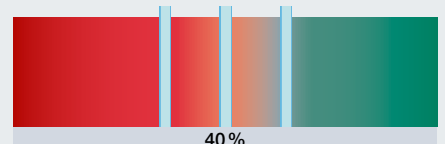

### DURATEC quadruple pane, 51 mm

In comparison to 16-mm glazing, the optional quadruple glazing increases the effective thermal insulation by up to **55 %**.

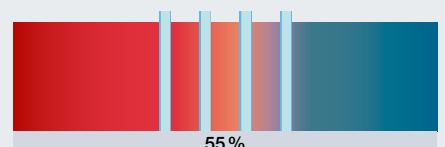

### Climatic double pane, 26 mm

Using this type of pane helps to minimise heat transmission. The improvement in thermal insulation is approx. **65 %**.

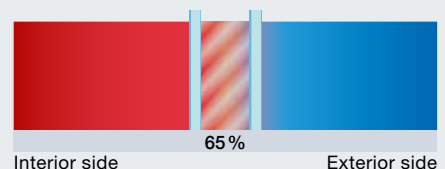



# Glazings, Infills

For more light and better ventilation

													
	DURATEC glazing	SPU F42	SPU 67 Thermo	APU F42	APU F42 Thermo	APU 67 Thermo	ALR F42	ALR F42 Thermo	ALR 67 Thermo	ALR F42 Glazing	ALR 67 Thermo Glazing	ALR F42 Vitraplan	

● = Possible

## Aluminium glazing frames

### Synthetic panes

Clear single pane	●	●		●			●					
Single pane, crystal structure		●		●			●					
Clear double pane	●	●		●	●		●	●				●
Double pane, crystal structure		●		●	●		●	●				●
Double pane, tinted brown, grey or white (opal)	●	●		●	●		●	●				
Clear triple pane	●	●	●	●	●	●	●	●	●			●
Triple pane, crystal structure		●	●	●	●	●	●	●	●			●
Triple pane, tinted in brown, grey or white (opal)	●	●	●	●	●	●	●	●	●			
Clear quadruple pane	●		●			●			●			
Quadruple pane, crystal structure			●			●			●			
Quadruple pane, tinted in brown, grey or white (opal)	●		●			●			●			

### Polycarbonate panes

Clear single pane	●	●		●			●					
Clear double pane	●	●		●	●		●	●				●

### Real glass panes

Clear single pane made of laminated safety glass		●		●			●			●		
Clear double pane made of single pane safety glass		●	●	●	●	●	●	●	●	●	●	
Clear climatic double pane made of single pane safety glass		●	●	●	●	●	●	●	●	●	●	

### Infills

Multiple-moulded pane		●		●	●		●	●				
Expanded mesh, stainless steel ventilation cross section: 58 % of the infill surface		●		●			●					
Perforated steel sheet, stainless steel ventilation cross section: 40 % of the infill surface		●		●			●					
PU-infill aluminium sheet cladding, anodised on both sides, smooth				●	●	●	●	●	●			
PU-infill, aluminium sheet cladding, Stucco-textured on both sides				●	●	●	●	●	●			

## Compound glazings

### Synthetic panes

Clear double pane, synthetic frame	●	A,D,E										
Clear double pane, diecast frame	●	A										
Clear triple pane, synthetic frame	●		D									
Clear triple pane, diecast frame	●		A									
Clear quadruple pane, diecast frame	●		A									

### Polycarbonate panes

Clear double pane, diecast frame	●	A										
----------------------------------	---	---	--	--	--	--	--	--	--	--	--	--

## Aluminium glazing frames



Standard profile / Thermo profile

## Standard profile / Thermo profile

### Glazing frame:

with / without thermal break

Standard: Anodised in natural finish E6 / C0

Optional: with colour coating

### Clear view:

Depending on version

### Rail extrusion:

52 mm, optional 91 mm (only for depth 42 mm)



Synthetic pane, clear



Synthetic pane, crystal structure



Synthetic pane, grey



Synthetic pane, brown



Synthetic pane, white (opal)



Multiple-moulded pane



Expanded mesh

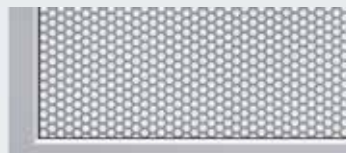

Perforated steel sheet



PU sandwich infill, smooth



PU sandwich infill, Stucco

## Compound glazings

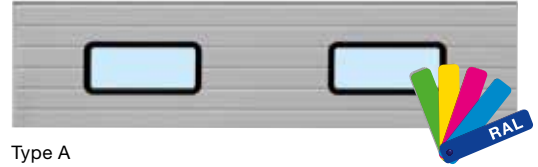

Type A

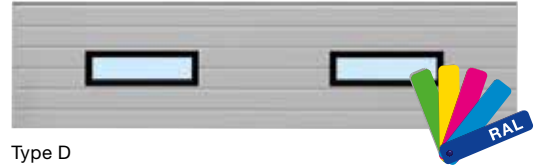

Type D

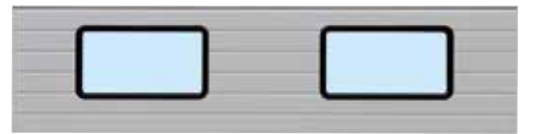

Type E

## Type A

### Glazing frame:

Standard: Plastic frame or diecast frame in black

Optional: Diecast frame with colour coating on the exterior

### Clear view:

635 × 245 mm

### Door section height:

500, 625, 750 mm

## Type D

### Glazing frame:

Standard: Plastic frame in black

Optional: with exterior colour coating

### Clear view:

602 × 132 mm

### Door section height:

500, 625, 750 mm

## Type E

### Glazing frame:

Standard: Plastic frame in black

### Clear view:

725 × 370 mm

### Door section height:

625, 750 mm

# Efficient Thermal Insulation

With a thermal break between frame and brickwork

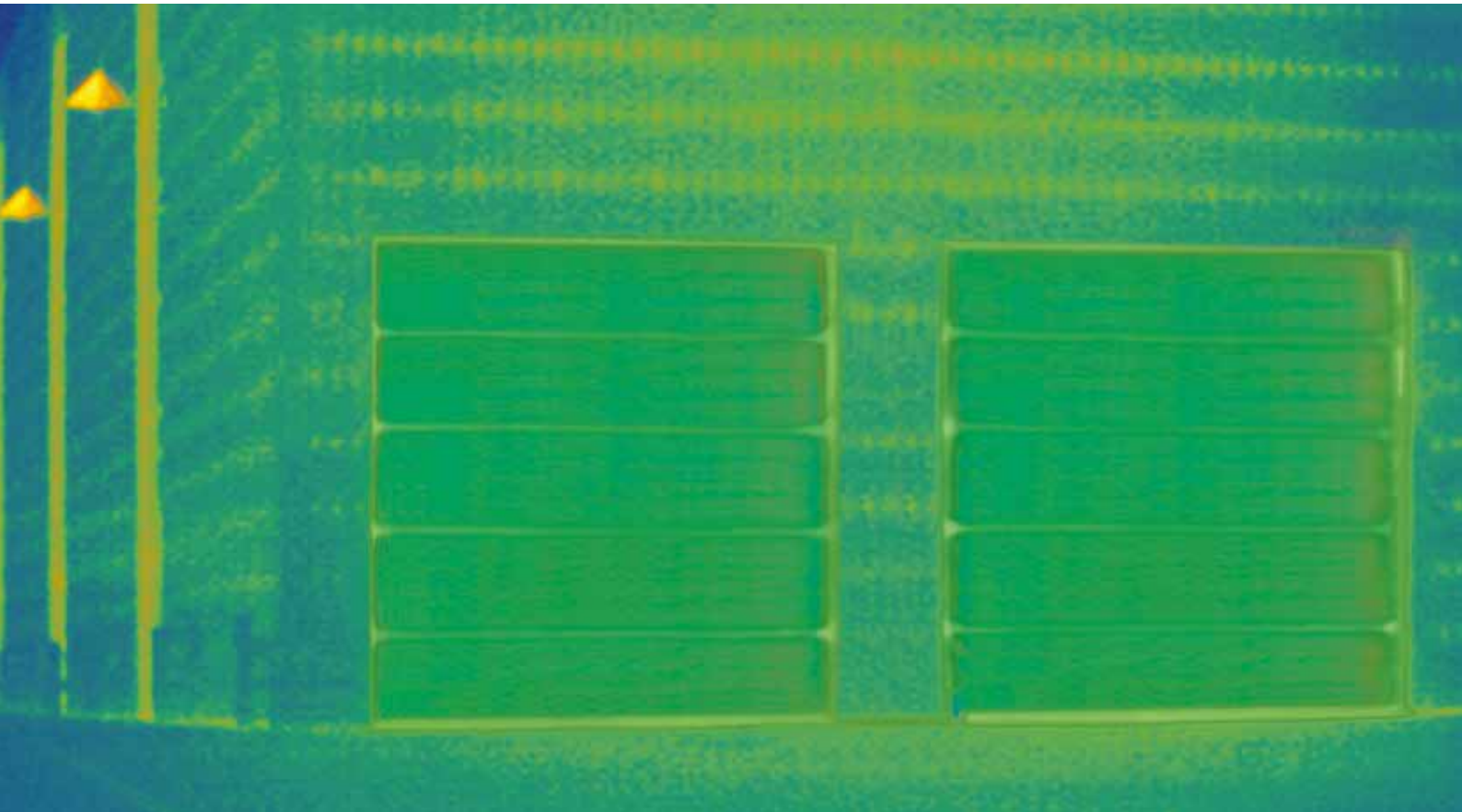

Optimum thermal insulation with SPU 67 Thermo

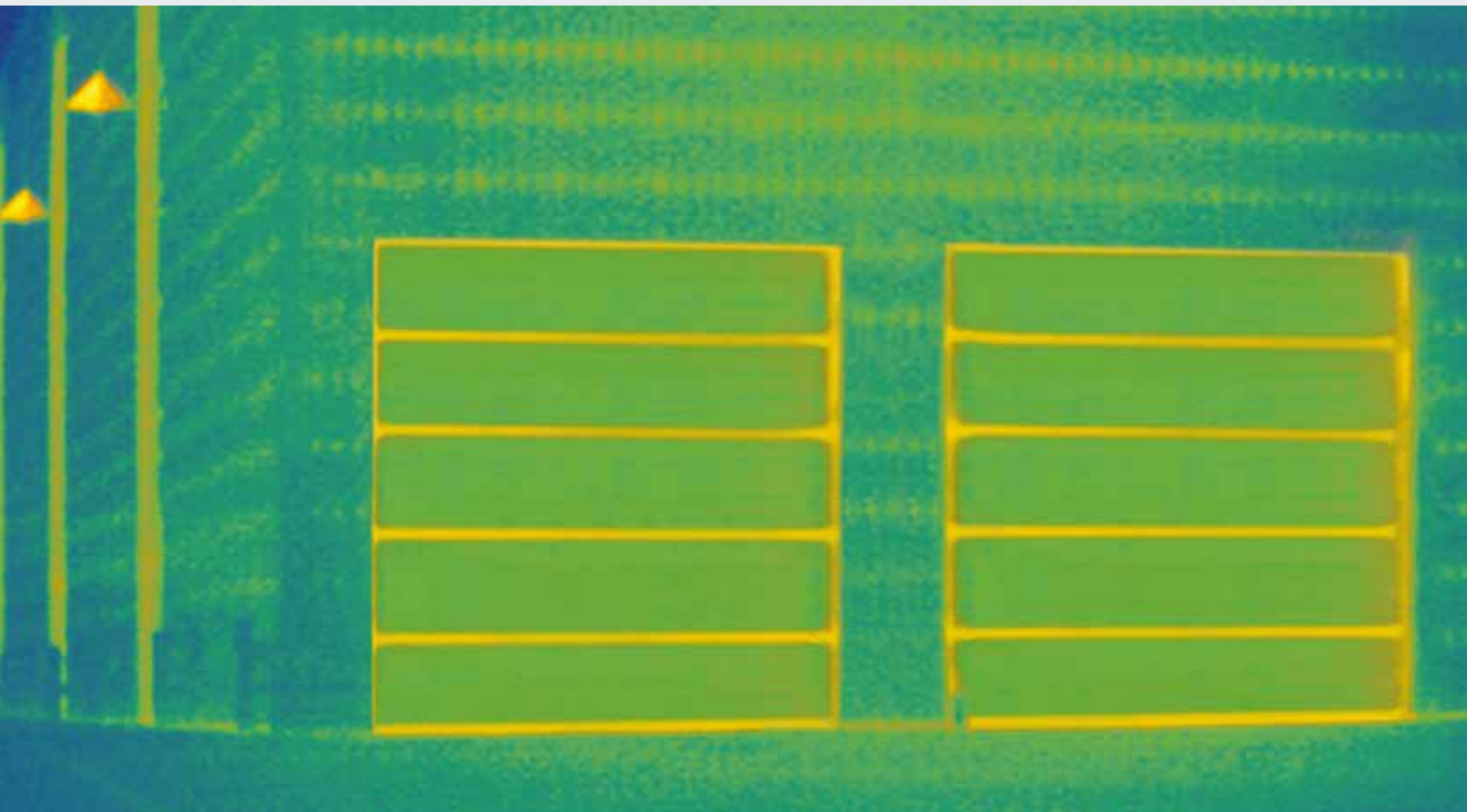

Good thermal insulation with SPU F42 Thermo



**Only from Hörmann**

## ThermoFrame optionally available for all industrial sectional doors

Well-insulated industrial sectional doors are essential in heated buildings. This is why Hörmann industrial sectional doors come with an optional ThermoFrame frame connection with a thermal break between the frame and brickwork. The lip seals on both door sides and the top section of the door provide additional insulation. This way you can decrease the thermal value by up to 21 %.

- Thermal break between the frame and brickwork
- Additional seals for improved tightness
- Easy to fit along with the door frame
- Optimum corrosion-protection of the side frame
- **Up to 21 % better thermal insulation** with the SPU 67 Thermo industrial sectional door with a door surface of 3000 × 3000 mm

Up to **21%** better thermal insulation

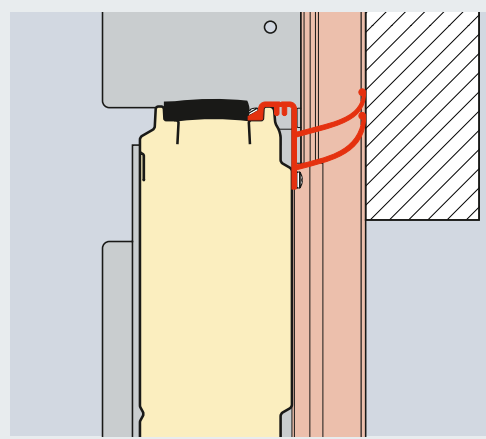

Lintel fitting with ThermoFrame

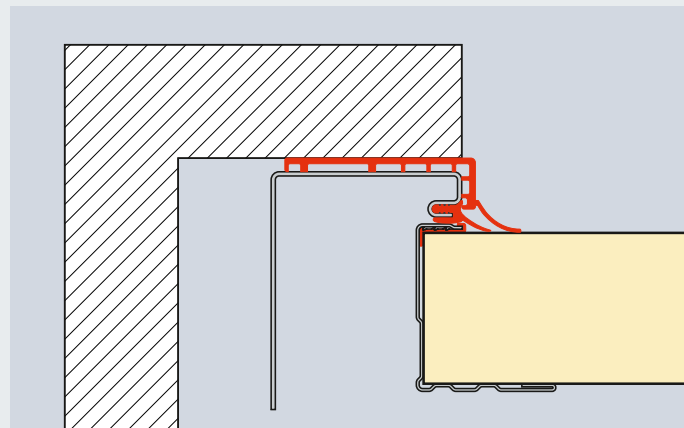

Sideroom with ThermoFrame

	Without ThermoFrame	With ThermoFrame	Improvement
	W/(m <sup>2</sup> ·K)	W/(m <sup>2</sup> ·K)	%
<b>SPU F42</b>			
Door surface (mm)			
3000 × 3000	1,22	1,07	12,3
4000 × 4000	1,10	0,99	10,0
5000 × 5000	1,03	0,94	8,7
<b>SPU 67 Thermo</b>			
Door surface (mm)			
3000 × 3000	0,81	0,64	21,0
4000 × 4000	0,69	0,56	18,8
5000 × 5000	0,62	0,51	17,7

# Examples of Track Versions

Sound planning for old and new buildings



## Track applications that fit precisely to the building

Whichever door type you have selected for your building: At Hörmann, you will find the track application to match your door. Depending on the building architecture and requirement, you can choose between standard and low headroom track applications, high-lift track applications or inclined track applications.

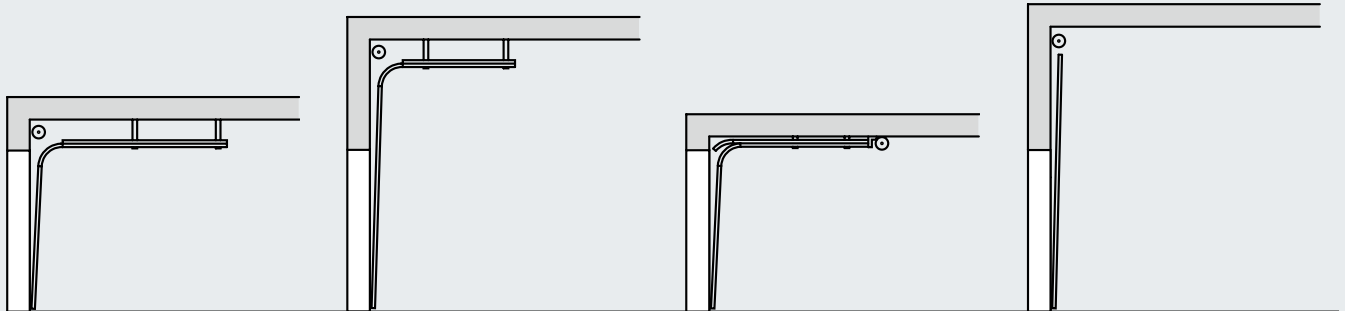

Track application N  
Normal track application

Track application H  
High-lift track application

Track application L\*  
Low headroom track application

Track application V  
Vertical track application

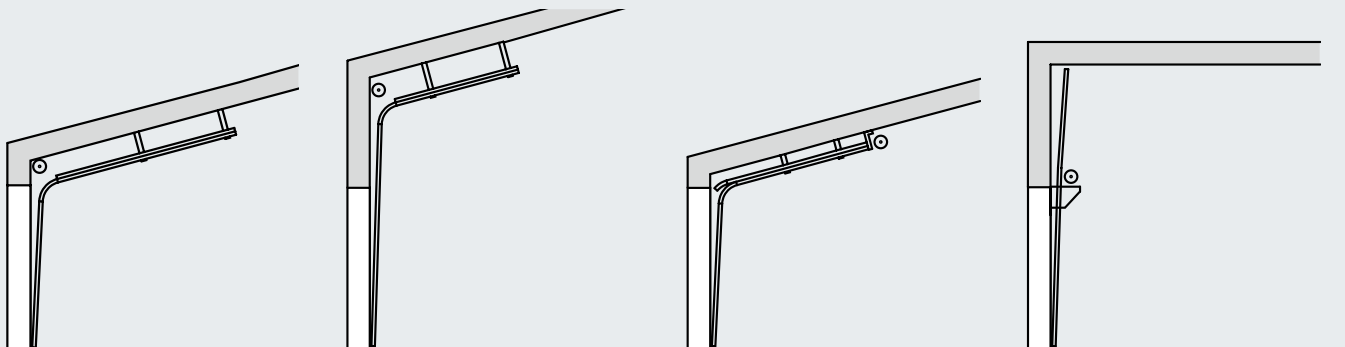

Track application ND  
With inclination

Track application HD  
With inclination

Track application LD\*  
With inclination

Track application VU  
With low-mounted spring shaft

Please see the valid technical manual for all of the available track applications.

\* Not for sectional door with 67 mm depth



### The low headroom track application

Operator and chain are directly on the door.  
An unsightly and potentially hazardous chain no longer dangles down. It pays to compare!

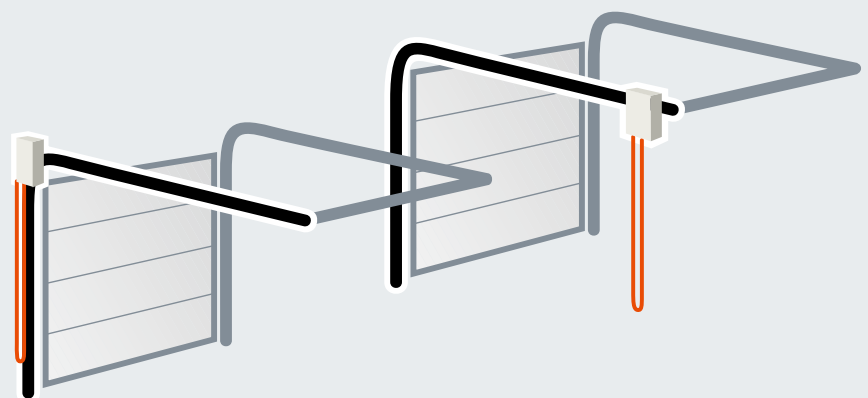

Hörmann's optimal arrangement

Competitors' disruptive arrangement



# The Best Proof of Quality: Advanced Technology in Every Detail



## **1 Quiet door travel**

Hinged roller holders made of galvanized steel with adjustable plastic rollers with ball-bearings ensure precise, quiet door travel.

## **Particularly service-friendly**

If the frame is damaged in a collision, the **bolted tracks** can be exchanged easily and inexpensively.

## **2 Galvanized, articulated roller holder**

The articulated roller holder reduces the headroom and protects the top door section from excessive bending when the door is open.

## **3 Strong-holding connections**

Stable centre hinges made of galvanized steel connect the individual door sections precisely. Edge profiling of the door sections has been designed so that the screws are held by multiple layers of sheet and are resistant to tearing out.

## **4 Upper frame end with connecting bracket**

Permanently defined positions for the spring shaft bracket make it easier to fit the entire spring shaft.

## **Connection of spring shaft to cable drum**

A separate feather key is not required; instead, a secure diecast connection increases functional safety and is easy to fit.

The shaft is galvanized, **the springs are coated.**

## **Flexible shaft coupling**

Low variation in the axial alignment can be compensated by the flexible shaft coupling.

## **5 Pre-fabricated suspension**

Ceiling suspension of the tracks is achieved through special anchors with slotted holes, made of galvanized steel. They are pre-fabricated as much as possible for the respective fitting situation.

SPU F42 shown

# Safety Features in Accordance With European Standard 13241



Doors must comply with the safety requirements of European standard 13241!

Have this confirmed by other manufacturers!

Hörmann products are tested and certified for:

## Anti-fall safeguard

### 6 Reliable door guidance

The rollers are guided precisely in a **safety track** developed by Hörmann. This is why the door leaf cannot fall out during the turning phase or when parked near the ceiling.

### 7 Optimum counterbalance

The torsion spring assembly with grooved spring shaft ensures an optimum counterbalance. As a result, the door moves easily during the entire opening and closing phase.

### 8 Catch safety device (depending on equipment)

This load-dependent latch device is integrated in the load carrier for protection in case a cable or spring breaks.

**European patent**

### 9 Spring safety device (depending on equipment)

Stops the torsion spring shaft if a spring breaks and securely holds the door in this position. **European patent**

## Trap protection

### 10 Finger trap protection

The unique form of the door sections eliminates trap points on doors with a depth of 42 mm, both on the outside and inside.

### 11 Internally guided cables

The carrying cables are guided on the inside between the door leaf and frame. No protruding components. This virtually eliminates the risk of injuries. For doors with a low headroom track application, the load carrier consists of a carrying chain / carrying cable.

### 12 Side trap guards

The side frames are completely closed from top to bottom. This side trap guard is particularly safe.

### 13 Closing edge safety device

With the operators WA 400 and ITO 400, sensors monitor the bottom edge of the door and stop and reverse it in case of danger. The same effect is provided by the power limit of operators WA 300 and SupraMatic HT. A leading photocell or a light grille ensures particularly safe monitoring of the closing edge (for further information, see page 70). Obstructions are detected before they come into contact with the door.

# Manually Operated Doors

As standard with pull rope or pull rod

## Optional operation options



Optional: Hand pulley with rope or link steel chain



Optional: Chain hoist



Optional: Chain tensioner for easier operation

## Securely locked as standard



### Shootbolt

This can be secured with an on-site padlock as a secure night lock.



**Only from Hörmann**

### Rotary latch

This door lock automatically locks itself through the latching disc. On request, it is also available for doors with VU and HU track applications (with low-mounted spring shaft).



**Only from Hörmann**

European patent

### Floor locking

This enables frequently used doors to be released by foot. The automatic latch audibly engages when closed.



# The Door Handle

## Standard security



### Lock operation from outside

With the handle set, the door lock can be ergonomically operated from outside. From inside, the lock is operated via T-handle and locking pin.

**The profile cylinder can also be integrated into central locking systems.**



Shootbolt



Rotary latch



### Recessed handle set

Vertical door guidance, ideal for logistics applications, thanks to a flat design and flexible installation height (dock doors). You can operate two functions with the locking cylinder: **permanently unlocked door and automatic re-locking.**

All parts on the inside are protected by cladding.



Shootbolt



Rotary latch

# Tightly Locked and Protected Against Forced Opening

Thanks to a break-in-resistant anti-lift kit

## Anti-lift kit as standard up to 5 m

It is also important for industrial doors to be reliably break-in-resistant to protect your goods and machines. At Hörmann, all industrial sectional doors up to 5 m height equipped with operators WA 300 S4 / WA 400 are supplied with a break-in-resistant anti-lift kit as standard. This mechanical protection reliably prevents the door from being forcefully pushed open, even in case of a power failure.

Industrial sectional doors over 5 m high are break-in-resistant due to their heavy weight.

In sectional doors with rail-guided operators, self-locking gearboxes (ITO 400) or patented locking in the operator boom (SupraMatic HT) protect against forced opening.

## Increased security for night doors

Hörmann offers optional locking systems for special protection. In power-driven doors, an additional mechanical shootbolt can be installed (see the figure on page 66). Because it is equipped with an electrical interrupter contact, the operator cannot be started if the door is locked.



The locking hook of the anti-lift kit automatically latches if the door is forced upwards.



Simple installation thanks to system components

## Better with a system

Hörmann has developed its own operators and controls. This means the components have been optimally adjusted to work together, ensuring the door's functional safety.

The uniform operating concept and the 7-segment display\* facilitate daily use. Fitting is also simplified thanks to uniform housing and cable sets. This way, all Hörmann products work together optimally and efficiently:

- Industrial doors
- Loading technology
- Operators
- Controls
- Accessories

Further information about the operators, controls and accessories can be found on pages 70 – 89.

\* Not for WA 300 with standard internal control



# Leading Photocell VL 1

Optional for all power-driven sectional doors

*No surcharge  
for WA 400 and  
ITO 400 operator*



## Increased safety

Thanks to the non-contact automatic safety cut-out, persons and obstacles are quickly recognised without door contact. The door stops before contact is made and immediately travels upwards. This virtually eliminates the risk of damage or injury.

## Faster door travel

The leading photocell can close the door at a speed of up to 30 cm/s. This reduces your energy costs due to shortened door opening times.

## Lower inspection and maintenance costs

Industrial doors with non-contact door monitoring approved for personal safety purposes do not need to have their closing force approved. This means you save the extra costs for the additional inspection in accordance with ASR A1.7.

## Closing edge safety device with optosensors or with leading photocell

All power-driven Hörmann industrial sectional doors with WA 400 and ITO 400 operators (also including the FU versions) are equipped with a self-monitoring closing edge safety device with optosensors as standard. You can also select the leading photocell VL 1 for non-contact door monitoring of the closing edge without a surcharge. This solution offers you increased safety, faster door action and lower inspection and maintenance costs.

**The non-contact, automatic safety cut-out protects people and property.**



Leading photocell VL 1



Leading photocell VL 2



The crash protection at the sides prevents the swivel arm from being damaged when the door is closed.



## Leading photocells

Using the leading photocells VL 1 and VL 2 means increasing the safety of Hörmann industrial sectional doors. The sensors monitor the bottom edge of the sectional door. Obstacles or persons are quickly recognised and the sectional door reverses before contact is made. Another benefit is the faster door travel speed.

# Light Grilles

## For maximum safety

### Light grilles

Light grilles recognise persons and obstacles without making contact. This virtually eliminates the risk of damage or injury. A closing edge safety device with optosensors or additional photocells is not required.

- **Maximum safety**  
Persons and obstacles are effectively recognised thanks to the cross-beam sensors.
- **Increased personal protection**  
Up to a height of 500 mm (above FFL) the sensors are arranged with an especially tight spacing.
- **Improved energy efficiency**  
The door can be shut at a speed of up to 45 cm/s (with operator WA 400 FU and control 460 FU, depending on track application and size).
- **Can be retrofitted**  
Existing doors with closing edge safety device with optosensors can be easily retrofitted with the HLG and HLG-V light grille.
- **Lower inspection and maintenance costs**  
Inspection of the closing force in accordance with ASR A1.7 is not necessary.

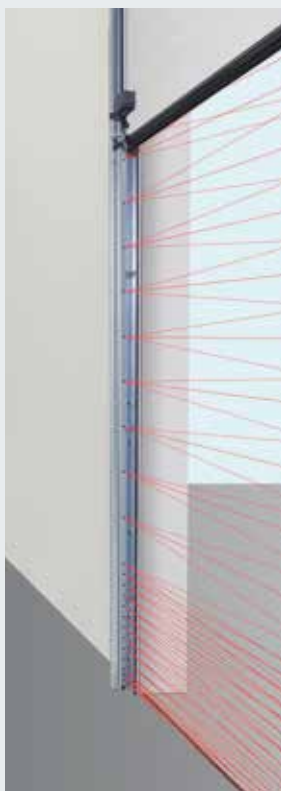

**Light grille HLG**  
Integrated into the frame

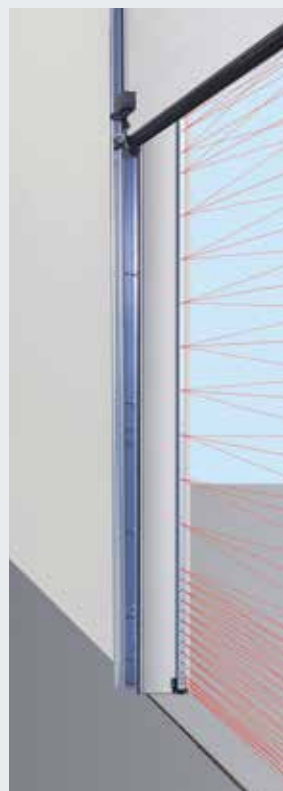

**Light grille HLG-V**  
Fitting in the reveal

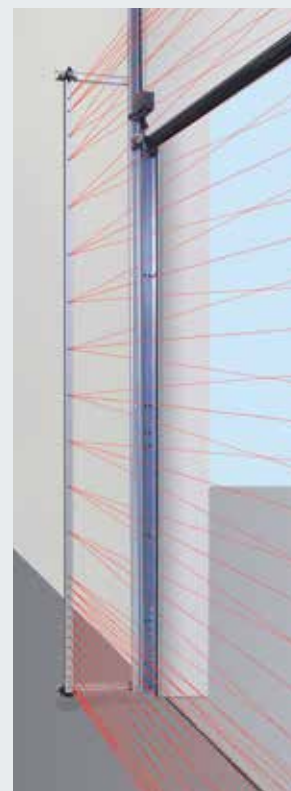

**Light grille HLG-V**  
Fitting to the door frame



**Light grille HLG**

The light grille fitted in the frame is well protected against damage or accidental readjustments. The fitting brackets allow it to be optimally fixed and aligned in the frame.

**Light grille HLG-V as advance protection**

The light grille additionally monitors the main closing edge of the door at a height of 2500 mm. Fitting is possible both on the outside on the facade and in the reveal as well as to the door frame. Optionally, the HLG-V can also be integrated into the key switch post set STL made of weather-resistant anodised aluminium.

**Light grille HLG for doors with wicket door**

A double light grille up to a height of 2500 mm effectively secures the closing edge of doors with wicket door with trip-free threshold. It is fitted on the inside to the frame and on the outside in the reveal. The radio transmission unit is required for transmission of the signal to the door leaf.



**Reflection photocell RL 50 / RL 300**

Photocell with transmitter / receiver unit and reflector. The photocell is tested by the control prior to each closing cycle. Connected via a system cable (RL 50, length 2 m) or a 2-wire cable (RL 300, length 10 m). Dimensions: 45 x 86 x 39 mm (W x H x D), protection category: IP 65 Reflector range up to 8 m (standard): 30 x 60 mm (W x H), reflector range up to 12 m (not shown): 80 mm diameter Optional: weather protective cover (not shown), anti-fog coating

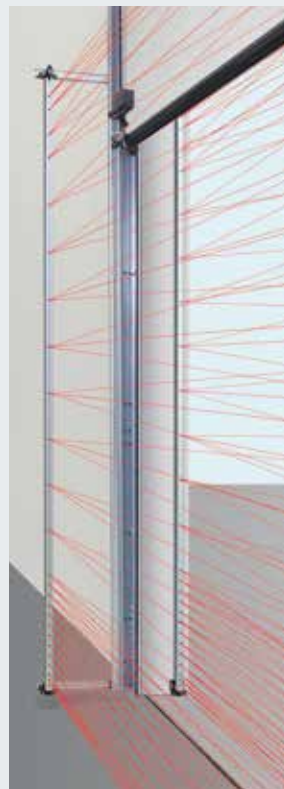
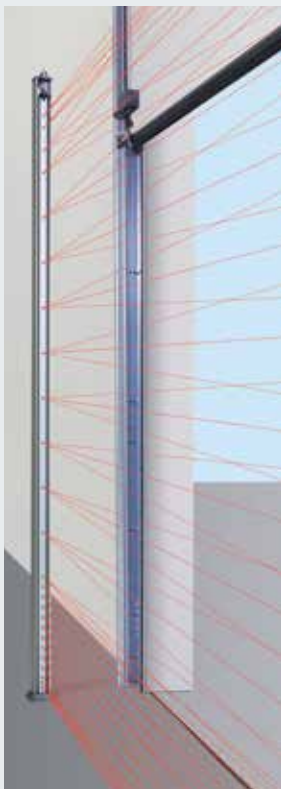

**One-way photocell EL 51**

Photocell with separate transmitter and receiver. The photocell is tested by the control prior to each closing cycle. Connected via a system cable Max. range 8 m Dimensions with fitting bracket: 45 x 85 x 31 mm (W x H x D), protection category: IP 65 Optionally: weather protective cover (not shown)

**Light grille HLG-V**

Fitting with key switch post set STL

**Light grille HLG**

For doors with wicket door

**Radio transmission unit**

Required for the light grille HLG for doors with wicket door, for further information, please see page 81

# Shaft Operator WA 300 S4

With standard soft start and soft stop

Now also available  
for track applications  
with inclination



## Soft start / soft stop

For gentle and quiet door travel. This sustainably increases the service life of the door system.



## Lower investments, lower consumption

The WA 300 S4 costs approx. 30 % less than a 3-phase current operator. At the same time, daily power consumption is reduced by up to 75 %.



## Simple, fast fitting and initial start-up

since many components have already been pre-assembled and no closing edge safety devices or cable slack switches have to be fitted.

For further information, please see the fitting data or contact your Hörmann partner.

## Advantages at a glance

### Particularly easy to fit and maintain thanks to its power limit as standard

For doors without wicket doors, installing items such as closing edge safety devices or cable slack switches on the door is not required. This reduces costs and the risk of repair and services.

### Safe "Close" door travel with reduced speed

All "Open" door travel as well as "Close" door travel above a 2500 mm opening height takes place at a speed of approx. 19 cm/s. With an opening height below 2500 mm, "Close" door travel must be set to approx. 10 cm/s for safety reasons.

### This restriction does not apply to optional leading photocells or closing edge safety devices, meaning the door opens and closes at approx. 19 cm/s.

### Integrated control with push button DTH R

The operator WA 300 S4 can also optionally be supplied with external control 360 (prepared for traffic control).

### Door sizes

Max. door width 6000 mm  
Max. door height 4500 mm

Max. 150 door cycles (Open / Close) per day or max. 10 door cycles (Open / Close) per hour



See the short film at:  
[www.hormann.co.uk/videos](http://www.hormann.co.uk/videos)



Diagonal fitting variant



Vertical fitting variant

## As standard for WA 300 S4

- Soft start and soft stop for gentle and quiet door travel
- Power limit in “Open” / “Close” directions
- Integrated control with push button DTH R
- Small side room of only 200 mm
- No installations or cabling required on the door\*
- No cable slack switch required
- Only approx. 1 watt power consumption in stand-by mode (if no other electrical accessories are connected)

\* Except for doors with wicket door



### Maintenance release directly on the operator

During the statutory annual door inspection, it is not necessary for the operator to be removed from the door shaft. This saves you time and money. The maintenance release can be converted to a secured release at any time.



### Combination control 420Si / 420Ti for operator and dock leveller

- Compact combination of basic dock leveller control and door control
- Easy to fit in a housing
- For operator WA 300 S4 with integrated control
- Prepared for retrofitting in control housing, e.g. option relay HOR1-300 for the Open limit switch reporting to release the dock leveller

## Optional releases



**Secured release on inside**  
For the convenient release of the operator from the floor (European patent)



**Secured release from outside ASE**  
To unlatch the door from the outside (required for buildings without a second entrance), lockable diecast housing with profile half cylinder dimensions:  
83 × 133 × 50 mm (W × H × D)

**Emergency operation**  
For manual operation of higher doors from 3000 mm (see figure on page 77)

**Emergency battery**  
With this emergency power in an external housing, you can bypass network power failures for up to 18 hours and max. 5 door cycles (dependent on the temperature and charge level). The emergency battery recharges itself during normal operation. For control 360, the emergency supply takes place via an optional UPS system (see page 81).



# Shaft Operator WA 400, WA 400 M

Strong and robust

## Operator to flange WA 400

This patented flange version is simple and quick to fit to the spring shaft and requires considerably less sideroom than the direct drive solutions from other manufacturers.

**Can be combined with controls**  
A / B 445, A / B 460, B 460 FU

## Operator with chain box WA 400

We recommend the WA 400 operator with chain box for all types of doors up to a height of 7500 mm if there is only sideroom of up to 200 mm. For applications L and LD an operator WA 400 with chain box is required. Due to the indirect transmission of forces, the door is subjected to minimum wear and friction.

**Can be combined with controls**  
A / B 445, A / B 460, B 460 FU

## Operator for central mounting WA 400 M

This version is mounted centrally on the spring shaft, as a result, no additional sideroom is necessary. Please observe the minimum headroom. The WA 400 M includes a secured release as a standard feature and is suitable for virtually any track application.

**Can be combined with controls**  
A / B 445, A / B 460, B 460 FU



Standard fitting position: horizontal, alternatively vertical, shown with an optional emergency hand chain



Standard fitting position vertical, shown with an optional emergency hand chain



Central mounting, when sideroom is lacking

**With all 3-phase current versions:**

- Exceptionally smooth running
- Long on-time
- Fast door travel
- Also as an FU version



**Standard maintenance release**

During the statutory annual inspection and maintenance work, it is not necessary for the operator to be removed from the door shaft. This saves you time and money. The maintenance release can be converted to a secured release at any time.



**Optional emergency operation for maintenance release**

**Emergency crank handle**

The low-cost option is available in two versions, as a fixed crank handle or jointed emergency crank handle. Retrofitting with an emergency hand chain is possible.



**Emergency hand chain**

Through a combination of the emergency hand chain and the optional secured release, the door can be released or operated from the floor.



**Emergency operation**

Recommended for doors over 3000 mm and fire station doors. A secured release is required.

**Meets the requirements of fire brigade standard DIN 14092 (with a depth of 42 to 5000 mm or a depth of 67 up to a door width of 5500 mm).**

**Optional releases**



**Secured release on inside**

(As standard with WA 400 M)  
For the convenient release of the operator from the floor (European patent)



**Secured release from outside ASE**

To release the door from the outside (required for buildings without a second entrance), lockable diecast housing with profile half cylinder dimensions:

83 x 133 x 50 mm (W x H x D)

# Direct Drive Operators

For doors without torsion spring shaft

## Direct drive operators S17.24 / S35.30 S75 / S140

- No torsion spring shaft required on the door
- As standard with leading photocell VL 1 **1** and lintel trap guard **2**
- Emergency hand chain as standard **3**
- Optionally with light grille HLG
- Can be combined with controls 445 R, 460 R

### Versions

#### S17.24

- Max. door leaf weight 180 kg
- Max. door width 4500 mm
- Max. door height 4500 mm

#### S35.30

- Max. door leaf weight 350 kg
- Max. door width 4500 mm
- Max. door height 4500 mm

#### S75

- Max. door leaf weight 700 kg
- Max. door width 10000 mm
- Max. door height 7500 mm

#### S140

- Max. door leaf weight 1080 kg
- Max. door width 10000 mm
- Max. door height 7500 mm





# Operator ITO 400, SupraMatic HT

## The space-saving operators

### Chain drive operator with boom guidance ITO 400

- No additional sideroom required
- Emergency release via Bowden cable on the slide carriage
- Maintenance release as standard
- Emergency release from the outside possible
- Optionally secured release on inside / outside (ideal for use on facade doors)
- IP 65 (jet-water protected)
- For normal track application (N, ND) and low headroom track application (L, LD)
- Max. door height 4500 mm
- Also available as FU version
- For doors with wicket door on request

Can be combined with controls A / B 445, A / B 460 and B 460 FU



### Operator SupraMatic HT

- Max. 300 door cycles (Open / Close) per day or max. 20 door cycles (Open / Close) per hour
- Pull and push force 1000 N (brief peak force 1200 N)
- With integrated control electronics including double 7-segment display for simple adjustment of the operator functions directly on the operator
- Optional external control 360 for connecting traffic control, warning lights or additional prints
- Soft start and stop for gentle, quiet door travel
- Patented door locking in the operator boom with emergency release from inside
- Connecting lead with EEC plug, second suspension
- For doors with a spring safety device
- SupraMatic HT: max. width 6750 mm (7000 mm on request), max. height 3000 mm
- For normal track application (N) and low headroom track application (L)
- For doors with wicket door, ALR F42 Glazing and real glass on request
- Not for sectional doors with a depth of 67 mm



# Controls

## Compatible system solutions



	Internal control WA 300 S4	External Control 360	Impulse control A / B 445, 445 R*	Comfort control A / B 460, 460 R*	FU control B 460 FU
<b>Operators</b>					
WA 300 S4	●	○			
WA 400, ITO 400			A / B 445	A / B 460	
WA 400 FU, ITO 400 FU					●
S75, S140, S17.24, S35.30			445 R	460 R	
<b>Functions / features</b>					
Control and operator can be mounted separately		●	●	●	●
Adjustments made conveniently directly on the control		●	●	●	●
Soft start and soft stop for gentle and quiet door travel	●	●			●
Adjustable high-speed opening and closing (depending on tracks)	● <sup>1)</sup>	● <sup>1)</sup>			●
Power limit in OPEN and CLOSE directions	● <sup>2)</sup>	● <sup>2)</sup>	A / B 445	A / B 460	●
Integrated Open / Stop / Close operation	●	●	●	●	●
Second opening height with additional button on the housing cover	○ <sup>3)</sup>	●		●	●
Menu reading from outside with a double 7-segment display (maintenance, cycle and operating hours counters as well as error analysis)		●	●	●	●
Collective malfunction signalling with on-site individual display: acoustic, visual, or e.g. via mobile phone		●	○	○	○
Extension possible with external radio receiver	●	●	●	●	●
Inquiry of the door position	○ <sup>4)</sup>	○ <sup>5)</sup>	○ <sup>5)</sup>	○ <sup>5)</sup>	○ <sup>5)</sup>
Automatic timer <sup>6)</sup>	●	●		●	●
Traffic control <sup>6)</sup>		○		○	○
Connecting terminals for additional command units	●	●	●	●	●
Power supply	230 V	230 V	400 / 230 V	400 / 230 V	230 V
Connection cable with CEE plug <sup>7)</sup> (Protection category IP 44)	●	●	●	●	●
Main switch integrated into control housing	○ <sup>8)</sup>	○	○	○	○
Protection category IP 65 (jet-water protected) for controls and door leaf components	●	●	●	●	●

● = As standard

○ = With corresponding equipment possibly with additional control

<sup>1)</sup> In the Close direction during operation without SKS / VL (during operation with SKS / VL, the door generally travels at high speed in the Close direction)

<sup>2)</sup> In accordance with EN 12453

<sup>3)</sup> Possible in combination with UAP 1-300 and DTH I or DTH IM

<sup>4)</sup> In combination with ESEi BS, HS 5 BS or Hörmann app (Gateway required)

<sup>5)</sup> In combination with HET-E2 24 BS, HS 5 BS or Hörmann app (Gateway required) and end-of-travel position feedback

<sup>6)</sup> Only in combination with an activating kit for warning light and photocell or light grille or leading photocell VL 1 / VL 2

<sup>7)</sup> For controls with integrated main switch the connecting cable is omitted

<sup>8)</sup> External main switch possible or through operating unit 300 U with integrated main switch



**Optional: Profile half cylinder**  
For all external controls



**Optional: Main switch**  
For all external controls

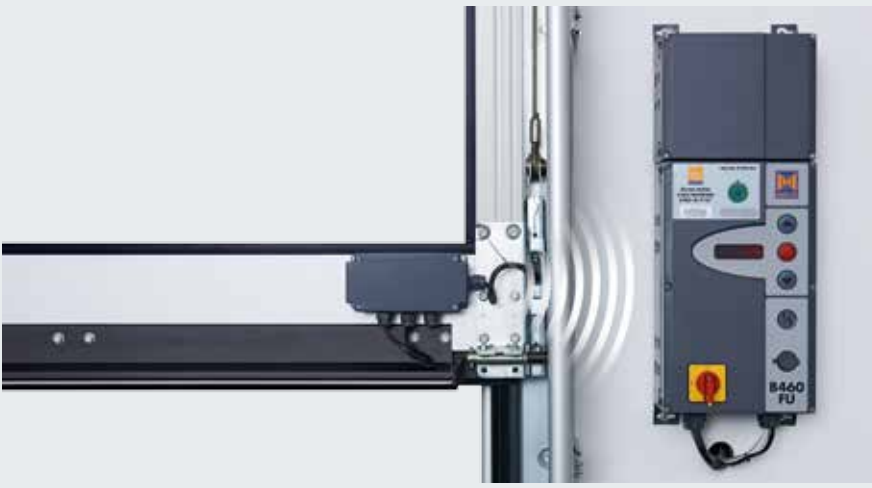

**Radio transmission unit**  
Optional equipment for transmission of signals from the door leaf to the control via Bluetooth – instead of a coiled cable. Power supply via a high-performance battery. Connectable components: optosensors LE (low energy), leading photocell VL 1 / 2-LE, 8k2 strip, cable slack switch, wicket door contact, night latch contact

For all controls

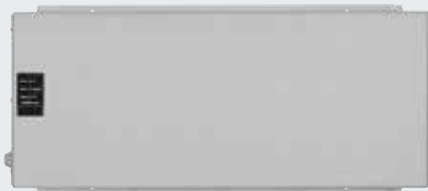

**UPS system**  
For bridging power failures of up to 4 hours, safety devices, warning lights, etc., remain functional, LED status display, automatic battery test, surge filter, dimensions: 560 × 235 × 260 mm (W × H × D), protection category: IP 20  
For controls: 360, B 445, B 460, B 460 FU



**Optional: Key switch post ST1 1**  
For installing a maximum of 2 controls with additional housing, colour: White aluminium, RAL 9006, dimensions: 200 × 1660 × 60 mm (W × H × D)



# Accessories

## Radio control, receiver

**Only from Hörmann**

### Hörmann BiSecur (BS)

#### The modern radio system for industrial door operators

The bi-directional radio system BiSecur is based on future-oriented technology for the convenient and secure operation of industrial doors. The extremely secure BiSecur encryption protocol makes sure that no-one can copy your radio signal. It was tested and certified by security experts at Bochum University.

#### Your advantages

- 128-bit encryption with the same high security level as online banking
- Interference-resistant radio signal with a stable range
- Convenient inquiry of the door position\*
- Backwards compatible, i.e. radio receivers with the frequency 868 MHz (2005 to June 2012) can also be operated with BiSecur control elements.



**5-button hand transmitter HS 5 BS**  
With additional button for querying the door position\*, high-gloss black or white, with chrome caps



**5-button hand transmitter HS 5 BS**  
With additional button for querying the door position\*, black textured surface, with chrome caps



**4-button hand transmitter HS 4 BS**  
Black textured surface with chrome caps



**1-button hand transmitter HS 1 BS**  
Black textured surface with chrome caps



**4-button security hand transmitter HSS 4 BS**  
Additional function: copy protection for hand transmitter coding, with chrome caps



**2-button hand transmitter HSE 2 BS**  
High-gloss black or white, with chrome caps



**4-button hand transmitter HSE 4 BS**  
Black textured surface with chrome or plastic caps



**1-button hand transmitter HSE 1 BS**  
Black textured surface with chrome caps



\* With WA 300 S4 with optional bi-directional receiver ESEi BS, for all other operators with optional bi-directional receiver HET-E2 24 BS and end-of-travel position feedback.



**Industrial hand transmitter**  
**HSI 6 BS, HSI 15 BS**  
 To control up to 6 doors (HSI 6 BS) or 15 doors (HSI 15 BS), with extra-large buttons for easier operation with work gloves, impact-resistant housing  
 Protection category: IP 65



**Radio code switch**  
**FCT 3 BS**  
 For 3 functions, with illuminated buttons



**Radio code switch**  
**FCT 10 BS**  
 For 10 functions, with illuminated buttons and protective cover



**Radio finger-scan**  
**FFL 12 BS**  
 For 2 functions and up to 12 fingerprints



**Industrial hand transmitter**  
**HSI BS**  
 To control up to 1000 doors, with a display and extra-large quick selection buttons for easier operation with work gloves, transferring of hand transmitter coding to other devices possible



**1-channel relay receiver**  
**HER 1 BS**  
 With volt-free relay output with status query



**2-channel relay receiver**  
**HER 2 BS**  
 With 2 volt-free relay outputs with status query and external antenna



**2-channel relay receiver**  
**HET-E2 24 BS**  
 With 2 volt-free relay outputs for choosing the direction, a 2-pin input for volt-free Open and Close limit switch reporting (for querying the door position)



**4-channel relay receiver**  
**HER 4 BS**  
 With 4 volt-free relay outputs with status query



**3-channel receiver**  
**HEI 3 BS**  
 For controlling 3 functions



**Bi-directional receiver**  
**ESEi BS**  
 For querying the door position



# Accessories

## Push buttons



### Push button DTH R

For separate control of both operational directions, with separate stop button, protection category: IP 65, dimensions: 90 × 160 × 55 mm (W × H × D)

#### For controls:

**360, A / B 445, A / B 460, B 460 FU and integrated control WA 300 S4**



### Push button DTH RM

For separate control of both operational directions, with separate stop button, with miniature lock: Control of the operator is deactivated. Operator movement is no longer possible (2 keys included in the scope of delivery).

protection category: IP 65, dimensions: 90 × 160 × 55 mm (W × H × D)

#### For controls:

**360, A / B 445, A / B 460, B 460 FU and integrated control WA 300 S4**



### Push button DTH I

To move the door into the Open / Close positions, separate stop button to stop door travel, 1/2 Open button to open the door up to the programmed intermediate travel limit, protection category: IP 65, dimensions: 90 × 160 × 55 mm (W × H × D)

#### For controls:

**360, A / B 460, B 460 FU and integrated control WA 300 S4** (only in combination with UAP 1)



### Push button DTH IM

To move the door into the Open / Close positions, separate stop button to stop door travel, 1/2 Open button to open the door up to the programmed intermediate travel limit, with miniature lock: operator control is deactivated. Operator movement is no longer possible (2 keys included in the scope of delivery).

protection category: IP 65, dimensions: 90 × 160 × 55 mm (W × H × D)

#### For controls:

**360, A / B 460, B 460 FU and integrated control WA 300 S4** (only in combination with UAP 1)



### Push button DT 02

Open or close via a command button, separate stop button, dimensions: 75 × 145 × 70 mm (W × H × D), protection category: IP 65

#### For controls:

**A / B 445, A / B 460 and B 460 FU**



### Push button DT 03

For separate control of both operational directions, with separate stop button, dimensions: 75 × 180 × 70 mm (W × H × D), protection category: IP 65

#### For controls:

**A / B 445, A / B 460 and B 460 FU**



### Push button DT 04

For separate control of both operational directions, with separate stop button, full or partial door opening (via a separate button), dimensions: 75 × 225 × 70 mm (W × H × D), protection category: IP 65

#### For controls:

**A / B 460 and B 460 FU**



### Push button DTN A 30

For separate control of both operational directions. The stop button is a push-to-lock button which, once pressed, stays depressed in order to prevent unauthorised operation. Subsequent actuation is then only possible once the stop button has been unlocked with a key (2 keys included in the scope of delivery). dimensions: 75 × 180 × 105 mm (W × H × D), protection category: IP 65

#### For controls:

**A / B 445, A / B 460 and B 460 FU**



# Accessories

## Push buttons, key switches, key switch posts



### Push button DTP 02

Open or close via a command button, separate stop button and operation control light for control voltage, lockable with profile half cylinder (available as an accessory), dimensions: 77 x 235 x 70 mm (W x H x D), protection category: IP 44

#### For controls:

A / B 445, A / B 460 and B 460 FU



### Push button DTP 03

For separate control of both operational directions, separate stop button and operation control light for control voltage, lockable with profile half cylinder (available as an accessory), dimensions: 77 x 270 x 70 mm (W x H x D), protection category: IP 44

#### For controls:

A / B 445, A / B 460 and B 460 FU



### Emergency-off button DTN 10

To quickly immobilise operation of the door system, push-to-lock button (mushroom button), surface-mounted, dimensions: 93 x 93 x 95 mm (W x H x D), protection category: IP 65

#### For controls:

A / B 445, A / B 460 and B 460 FU



### Emergency-off button DTNG 10

To quickly immobilise operation of the door system, push-to-lock mushroom button, surface-mounted, dimensions: 93 x 93 x 95 mm (W x H x D), protection category: IP 65

#### For controls:

A / B 445, A / B 460 and B 460 FU

The lockable function serves to isolate the control voltage and immobilises the command units. Profile half cylinders are not included in the scope of delivery for the push buttons.



### Key switch ESU 30 with 3 keys

Recessed version, Impulse or Open / Close functions selectable, dimensions of the switch box: 60 mm (d), 58 mm (D), dimensions of the cover: 90 x 100 mm (W x H), brickwork recess: 65 mm (d), 60 mm (D), protection category: IP 54

Surface-mounted version ESA 30

(not shown)

Dimensions:

73 x 73 x 50 mm (W x H x D)



### Key switch STUP 50 with 3 keys

Recessed version, dimensions: 80 x 80 mm (W x H), protection category: IP 54

### Key switch STAP 50 with 3 keys

Surface-mounted version (not shown) Dimensions: 80 x 80 x 63 mm (W x H x D)



### Pull switch ZT 2 with cord

Impulse transmission to open or close the door, dimensions: 60 x 90 x 55 mm (W x H x D), pull cord length: 3.2 m, protection category: IP 65

Cantilever arm KA1 (not shown)

Extension 1680 - 3080 mm, can be used with ZT 2



### Key switch posts

With screw base for fitting to the floor, surface in White aluminium RAL 9006, tube 90 x 90 mm, also available as set-in-concrete version

### Key switch post STN 1 // NEW

To hold 1 command unit on the surface, height 1050 mm

### Key switch post STN 1-1 // NEW

To hold 2 command units or 1 command unit and 1 warning light, height 1200 mm

### For command units:

CTR 1b-1, CTR 3b-1, CTV 3-1, CTP 3-1, TTR 1000-1, FL 150, STUP 50, HLA 1, double LED warning lights red / green

# Accessories

## Code switches



**Code switch CTR 1b-1, CTR 3b-1**  
For 1 (CTR 1b-1) or 3 (CTR 3b-1) functions, with illuminated buttons

Dimensions:  
80 × 80 × 15 mm (W × H × D)



**Code switch CTV 3-1**  
For 3 functions, with particularly robust metal keypad

Dimensions:  
80 × 80 × 15 mm (W × H × D)



**Code switch CTP 3**  
For 3 functions, with illuminated lettering and touch-sensitive surface

Dimensions:  
80 × 80 × 15 mm (W × H × D)



**Decoder housing**  
For code switch CTR 1b-1, CTR 3b-1, CTV 3-1, CTP3

Dimensions:  
140 × 130 × 50 mm (W × H × D),  
switching capacity: 2.5 A / 30 V DC  
500 W / 250 V AC



### Finger-scan FL 150

For 2 functions, up to 150 fingerprints can be saved

Dimensions:  
80 × 80 × 13 mm (W × H × D),  
decoder housing:  
70 × 275 × 50 mm (W × H × D),  
switching capacity: 2.0 A / 30 V DC



### Transponder key switch TTR 1000-1

For 1 function via transponder key or transponder card, up to 1000 keys or cards can be saved

Dimensions:  
80 × 80 × 15 mm (W × H × D),  
decoder housing:  
140 × 130 × 50 mm (W × H × D),  
switching capacity: 2.5 A / 30 V DC  
500 W / 250 V AC



# Accessories

Activating kits, LED warning lights



Traffic lights with bright, long-lasting LEDs



### Multi-function circuit board to be fitted in an existing housing or optionally in a separate extension housing (shown)

Limit switch reporting, momentary impulse, collective malfunction signalling, extension unit for controls 360, A / B 445, A / B 460, B 460 FU

Dimensions of additional housing:  
202 × 164 × 130 mm (W × H × D),  
protection category: IP 65  
A circuit board can be optionally mounted in the control.

### Digital weekly timer in a separate additional housing

The timer can switch command units on and off via a volt-free contact. Extension unit for controls A / B 460, B 460 FU, 360 (without additional housing, for fitting in existing housing), switching capacity: 230 V AC 2.5 A / 500 W, can be switched over to summer/winter time, manual switching: automatic operation, switching preselection permanently ON / OFF

Dimensions of additional housing:  
202 × 164 × 130 mm (W × H × D),  
protection category: IP 65

### Summer / winter activating kit in additional housing

Function for full door opening and individually programmable intermediate travel limit, extension unit for controls A / B 460, B 460 FU

Dimensions of additional housing:  
202 × 164 × 130 mm (W × H × D),  
protection category: IP 65



### Activating kit for warning lights for fitting in an existing housing or optionally in a separate extension housing (shown), incl. 2 yellow warning lights

Extension unit for controls 360, A / B 445, A / B 460, B 460 FU. The activating kit for warning lights serves as a visual indicator during door operation (weekly timer, optionally for 360, A / B 460, B 460 FU). Applications: approach warning (for 360, A / B 445, A / B 460, B 460 FU), automatic timer (for 360, A / B 460, B 460 FU). After the set hold-open phase has elapsed (0 – 480 s), the warning lights flash during the set pre-warning phase (0 – 70 s).  
Traffic light dimensions: 180 × 250 × 290 mm (W × H × D),  
dimensions of additional housing: 202 × 164 × 130 mm (W × H × D),  
contact load: 250 V AC: 2.5 A / 500 W,  
protection category: IP 65

### Traffic control in a separate additional housing (A / B 460, B 460 FU) or for fitting in an existing housing (360) incl. 2 red / green traffic lights

Extension unit for controls 360, A / B 460, B 460 FU. The activating kit for warning lights serves as a visual indicator for regulating the entrance and exit (optional weekly timer).  
Duration of the green phase: adjustable 0 – 480 s  
Duration of the clearance phase: adjustable 0 – 70 s  
Traffic light dimensions: 180 × 410 × 290 mm (W × H × D),  
dimensions of additional housing: 202 × 164 × 130 mm (W × H × D),  
Contact load: 250 V AC: 2.5 A / 500 W,  
protection category: IP 65



# Accessories

## Activating kits

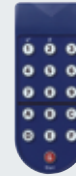

### DI 1 induction loop in a separate additional housing

Suitable for one induction loop. The detector has a normally open contact and a change-over contact.

### DI 2 induction loop (not shown) in a separate additional housing

Suitable for two separate induction loops. The detector has two volt-free normally open contacts. Can be set for impulse or permanent contact, directional recognition possible.

Dimensions of additional housing:

202 × 164 × 130 mm (W × H × D),

switching capacity:

DI 1: low voltage 2 A, 125 V A/60 W,

DI 2: 250 V AC, 4 A, 1000 VA (resistive load AC),

supplied without loop cable

### Loop cable for induction loop

Roll of 50 m,

cable designation: SIAF,

cross-section: 1.5 mm<sup>2</sup>,

colour: brown

### Radar movement detector RBM 2

For "Open door" impulse with directional recognition

Max. fitting height: 6 m

Dimensions:

155 × 132 × 58 mm (W × H × D),

contact load:

24 AC/DC, 1 A (resistivity),

protection category: IP 65

### Optional remote control for radar movement detector



### UAP 1-300

#### For WA 300 S4

For impulse selection, partial opening function, limit switch reporting and activating kit for warning light with 2 m system cable, protection category: IP 65

Max. switching capacity:

30 V DC / 2.5 A (resistivity),

250 V AC / 500 W (resistivity),

dimensions:

150 × 70 × 52 mm (W × H × D)

### HOR 1-300

#### For WA 300 S4

To control limit switch reporting or warning lights with 2 m connecting lead, protection category: IP 44

Max. switching capacity:

30 V DC / 2.5 A (resistivity),

250 V AC / 500 W (resistivity),

dimensions:

110 × 45 × 40 mm (W × H × D)

Also optionally available for integration into the push button control 300 U (not shown)

# Special Control Construction

## Hörmann is your partner for special solutions

Hörmann offers you a complete and individual control concept from a single source: From the integration of the Hörmann special control into your control concept via a complete central control for all functional processes, up to a PC-based visualisation of all door and loading components.

### **High-quality individual components, compatible with the Hörmann operator technology**

Each special control is based on a Hörmann serial control. For additional components, such as programmable storage controls, switching elements, etc. we only use standardised, tested components by high-quality suppliers. This ensures reliable and long-term functioning of the special control.

### **Individual practical tests ensure easy handling**

In addition to process and system tests, in combination with voltage and isolation tests, we generally also test our special controls in practical application. In addition to optimal functioning, this also guarantees high user friendliness.

### **Individual product development**

The entire electrical planning is developed and tested in-house. The electrical documentation is prepared via E-Plan and guarantees great modularity and comprehensibility of the wiring scheme. Integration into customer-specific systems includes technical co-ordination with the customer requirements or the factory standards.

### **Controlled processes through visualisation**

You control, monitor and manage the entire control system via a graphic user interface. It is presented on a control panel or via a web application.

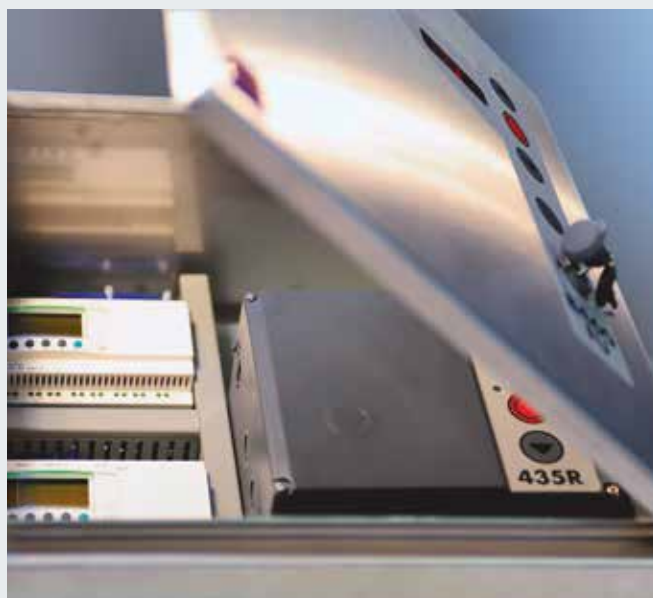

# Performance Characteristics According to EN 13241

Door types	SPU F42	SPU 67 Thermo	APU F42	APU F42 Thermo	APU 67 Thermo	ALR F42	ALR F42 Thermo	ALR 67 Thermo	
<b>Wind load</b>	Class according to EN 12424								
Up to door widths of 8000 mm	3 <sup>1,2)</sup>	3 <sup>1,2)</sup>	3 <sup>1)</sup>	3 <sup>1)</sup>	3 <sup>1)</sup>	3 <sup>1)</sup>	3 <sup>1)</sup>	3 <sup>1)</sup>	
From door widths of 8000 mm		2			2			2	
<b>Water tightness</b>	Class according to EN 12425								
	3 (70 Pa)	3 (70 Pa)	3 (70 Pa)	3 (70 Pa)	3 (70 Pa)	3 (70 Pa)	3 (70 Pa)	3 (70 Pa)	
<b>Air permeability</b>	Class according to EN 12426								
Sectional door without wicket door	2	2	2	2	2	2	2	2	
Sectional door with wicket door	1	1	1	1	1	1	1	1	
<b>Acoustic insulation<sup>3)</sup></b>	R [db] according to EN ISO 717-1								
Sectional door without wicket door	25	25	23	23	23	23	23	23	
With real glass panes						30	30	30	
Sectional door with wicket door	24	24	22	22	22	22	22	22	
<b>Thermal insulation</b>	U value = W/(m <sup>2</sup> ·K) according to EN 13241, Appendix B, for a door size of 5000 × 5000 mm								
Sectional doors with / without wicket door									
Fitted door	1.0 / 1.2	0.62 / 0.82							
With ThermoFrame	0.94 / 1.2	0.51 / 75							
Synthetic double panes			3.4 / 3.6	2.9 / 3.1		3.6 / 3.8	3.0 / 3.2		
With ThermoFrame			3.3 / 3.6	2.8 / 3.1		3.6 / 3.8	3.0 / 3.2		
Synthetic triple panes			3.0 / 3.2	2.5 / 2.7	2.1 / 2.3	3.2 / 3.4	2.6 / 2.8	2.2 / 2.4	
With ThermoFrame			2.9 / 3.1	2.4 / 2.6	2.0 / 2.2	3.1 / 3.4	2.5 / 2.8	2.1 / 2.3	
Synthetic quadruple pane					1.8 / 2.0			1.9 / 2.1	
With ThermoFrame					1.7 / 1.9			1.8 / 2.1	
Climatic double pane			2.5 / 2.7	2.0 / 2.2	1.6 / 1.8	2.7 / 2.9	2.1 / 2.3	1.7 / 1.9	
With ThermoFrame			2.4 / 2.6	1.9 / 2.1	1.5 / 1.7	2.6 / 2.8	2.0 / 2.2	1.6 / 1.8	
Double real glass pane			3.4 / 3.6	2.9 / 3.1	2.6 / 2.8	3.6 / 3.8	3.0 / 3.2	2.7 / 2.9	
With ThermoFrame			3.3 / 3.6	2.8 / 3.0	2.5 / 2.7	3.6 / 3.8	3.0 / 3.2	2.6 / 2.8	
Single real glass pane									
With ThermoFrame									

<sup>1)</sup> With wicket door and door width over 4000 mm, class 2

<sup>2)</sup> With compound windows, lower classes may be possible

<sup>3)</sup> For combined infills, the weaker one is the critical infill (e.g. APU, SPU with glazing frame).

Side doors	NT 60 for SPU	NT 60 for APU	NT 60 for ALR	NT 60 for ALR Vitraplan	NT 80 Thermo for SPU	NT 80 Thermo for APU	NT 80 Thermo for ALR
<b>Wind load</b>	3C	3C	3C	3C	4C	4C	4C
Class according to EN 12424							
<b>Air permeability</b>	3	3	3	3	3	3	3
Class according to EN 12426							
<b>Watertightness under heavy rain</b>	1A	1A	1A	1A	1A	1A	1A
Unprotected, opening outwards							
<b>Thermal insulation</b>	2,9	4,2	4,7	4,7	1,6	2,2	2,4
U value = W/(m <sup>2</sup> ·K) according to EN 13241, Appendix B, for a door size of 1250 × 2200 mm							



	ALR F42 Glazing	ALR 67 Thermo Glazing	ALR F42 Vitraplan
	3	3 2	3
	3 (70 Pa)	3 (70 Pa)	3 (70 Pa)
	2	2	2
	30	30	23
			3,2
			3,2
			3,1
			3,1
	2.7 / -	1.8 / -	
	2.6 / -	1.7 / -	
	3.8 / -	3.0 / -	
	3.8 / -	2.9 / -	
	6.1 / -		
	6.1 / -		

Glazings / infills	U <sub>g</sub> value W/(m <sup>2</sup> ·K)	τ <sub>v</sub> value	g value
<b>Synthetic panes</b>			
<b>Single pane, 3 mm</b>			
Clear		0,88	
Crystal structure		0,84	
<b>Double pane, 26 mm</b>			
Clear	2,6	0,77	0,74
Crystal structure	2,6	0,77	0,74
Grey tinted	2,6	0,03	0,28
Brown tinted	2,6	0,03	0,25
White tinted (opal)	2,6	0,69	0,69
<b>Triple pane, 26 mm</b>			
Clear	1,9	0,68	0,67
Crystal structure	1,9	0,68	0,67
Grey tinted	1,9	0,03	0,25
Brown tinted	1,9	0,03	0,23
White tinted (opal)	1,9	0,61	0,63
<b>Triple pane, 51 mm</b>			
Clear	1,6	0,68	0,67
Crystal structure	1,6	0,68	0,67
Grey tinted	1,6	0,03	0,25
Brown tinted	1,6	0,03	0,22
White tinted (opal)	1,6	0,61	0,63
<b>Quadruple pane, 51 mm</b>			
Clear	1,3	0,60	0,61
Crystal structure	1,3	0,60	0,61
Grey tinted	1,3	0,02	0,23
Brown tinted	1,3	0,02	0,20
White tinted (opal)	1,3	0,54	0,58
<b>Polycarbonate panes</b>			
<b>Single pane, 6 mm</b>			
Clear	-	-	-
<b>Double pane, 26 mm</b>			
Clear	2,7	0,81	0,75
<b>Real glass panes</b>			
<b>Single pane, 6 mm</b>			
Clear	5,7	0,88	0,79
<b>Double pane, 26 mm</b>			
Clear	2,7	0,81	0,76
<b>Climatic double pane, 26 mm</b>			
Clear	1,1	0,80	0,64
<b>Infill</b>			
<b>Multiple-moulded pane</b>			
	1,9	0,57	0,62

Vitraplan attachments on request

U<sub>g</sub> value Thermal insulation value  
τ<sub>v</sub> value Light transmission (transparency)  
g value Total energy transmittance

# Construction and Quality Features

● = Standard

○ = Optional

	SPU F42	SPU 67 Thermo	APU F42	APU F42 Thermo	APU 67 Thermo	
<b>Construction</b>						
Self-supporting	●	●	●	●	●	
Depth, mm	42	67	42	42	67	
<b>Door sizes</b>						
Max. width mm, LZ	8000	10000	8000	7000	10000	
Max. height mm, RM	7500	7500	7500	7500	7500	
<b>Material, door leaf</b>						
Double-skinned steel section	●	-	●	●	-	
Double-skinned steel section with thermal break	-	●	-	-	●	
Aluminium profile	-	-	●	-	-	
Aluminium profile with thermal break	-	-	-	●	●	
<b>Surface, door leaf</b>						
Galvanized steel, coated RAL 9002	●	●	○	○	○	
Galvanized steel, coated RAL 9006	○	○	●	●	●	
Galvanized steel, coated RAL to choose	○	○	○	○	○	
Anodised aluminium E6 / C0	-	-	●	●	●	
Aluminium coated in RAL to choose	-	-	○	○	○	
Aluminium coated in brown / grey	-	-	-	-	-	
<b>Wicket door</b>	○	○	○	○	○	
<b>Side doors</b>						
Side door NT 60 matching the door	○	○	○	○	○	
Side door NT 80 Thermo matching the door	○	○	○	○	○	
Type A section windows	○	○	-	-	-	
Type D section windows	○	○	-	-	-	
Type E section windows	○	-	-	-	-	
Aluminium glazing frames	○	○	●	●	●	
<b>Seals</b>						
All-round on 4 sides	●	●	●	●	●	
Intermediate seal between the door sections	●	●	●	●	●	
<b>ThermoFrame</b>	○	○	○	○	○	
<b>Locking systems</b>						
Inside locking	●	●	●	●	●	
Outside / inside locking	○	○	○	○	○	
<b>Anti-lift kit</b>						
For doors of up to 5 m with shaft operator	●	●	●	●	●	
<b>Safety equipment</b>						
Finger trap protection	●	-	●	●	-	
Side trap guards	●	●	●	●	●	
Safety catch for doors	●	●	●	●	●	
<b>Fastening options</b>						
Concrete	●	●	●	●	●	
Steel	●	●	●	●	●	
Brickwork	●	●	●	●	●	
Others on request						

	ALR F42	ALR F42 Thermo	ALR 67 Thermo	ALR F42 Glazing	ALR 67 Thermo Glazing	ALR F42 Vitraplan
	● 42	● 42	● 67	● 42	● 67	● 42
	8000 7500	7000 7500	10000 7500	5500 4000	5500 4000	6000 7000
	- - ● -	- - - ●	- - - ●	- - ● -	- - - ●	- - ● -
	- - - ● ○ -	- - - ● ○ -	- - - ● ○ -	- - - ● ○ -	- - - ● ○ -	- - - - - ●
	○ ○	○ ○	○ ○	- -	- -	- -
	○ ○	○ ○	○ ○	○ ○	○ ○	○ -
	- - - ●	- - - ●	- - - ●	- - - ●	- - - ●	- - - ●
	● ●	● ●	● ●	● ●	● ●	● ●
	○	○	○	○	○	○
	● ○	● ○	● ○	● -	● -	● -
	●	●	●	●	●	●
	● ● ●	● ● ●	- ● ●	● ● ●	- ● ●	● ● ●
	● ● ●	● ● ●	● ● ●	● ● ●	● ● ●	● ● ●



# Hörmann Product Range

Everything from a single source for your construction project





**Quick service with testing, maintenance and repairs**  
 Our extensive service network means that we are always nearby and at your service around the clock.

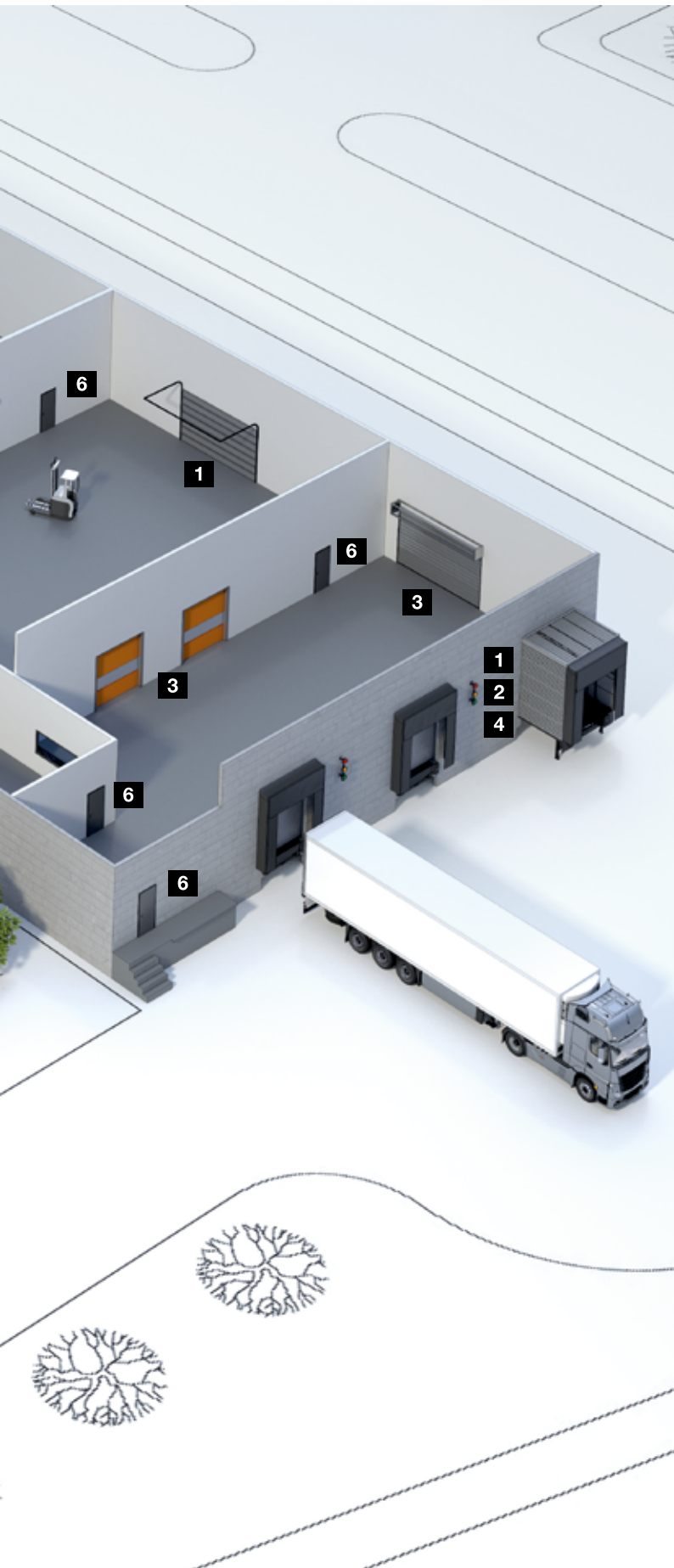

**Sectional doors**



**Rolling shutters and rolling grilles**



**High-speed doors**



**Loading technology**



**Steel and stainless steel sliding doors**



**Steel and aluminium multi-function doors**



**Steel and stainless steel doors**



**Steel frames with high-quality timber function doors from Schörghuber**



**Fully glazed tubular frame parts**



**Automatic sliding doors**

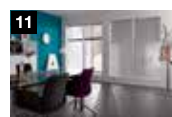

**Visibility window**



**Collective garage doors**



**Perimeter Protection Systems**



# Hörmann: Quality without Compromise



Hörmann KG Amshausen, Germany



Hörmann KG Antriebstechnik, Germany



Hörmann KG Brandis, Germany



Hörmann KG Brockhagen, Germany



Hörmann KG Dissen, Germany



Hörmann KG Eckelhausen, Germany



Hörmann KG Freisen, Germany



Hörmann KG Ichttershausen, Germany



Hörmann KG Werne, Germany



Hörmann Alkmaar B.V., Netherlands



Hörmann Legnica Sp. z o.o., Poland



Hörmann Beijing, China



Hörmann Tianjin, China



Hörmann LLC, Montgomery IL, USA



Hörmann Flexon LLC, Burgettstown PA, USA



Shakti Hörmann Pvt. Ltd., India

Hörmann is the only manufacturer worldwide that offers you a complete range of all major building products from one source. We manufacture in highly-specialised factories using the latest production technologies. The close-meshed network of sales and service companies throughout Europe, and activities in the USA and Asia, make Hörmann your strong partner for first-class building products, offering "Quality without Compromise".

**GARAGE DOORS**  
**OPERATORS**  
**INDUSTRIAL DOORS**  
**LOADING EQUIPMENT**  
**HINGED DOORS**  
**DOOR FRAMES**

